



The perfect solution for every roof



Mounting systems 2022



1	<u>Pitched roof</u>	11
2	<u>Single items pitched roof</u>	59
3	<u>Flat roof</u>	93
4	<u>Single items flat roof</u>	109
5	<u>Customized solution</u>	127
6	<u>Appendix</u>	132

At home on any roof. novotegra mounting systems

Technical innovations and products alone are not enough.
With the right partner at your side, you will be in a perfect position.

Here at novotegra GmbH, we manufacture our own mounting systems, specially developed for photovoltaic installations. We distribute all the components required to safely install photovoltaic systems via our Europe-wide wholesale business. Our systems can be installed on practically any common roof type, from standard pitched roofs and flat roofs to special solutions and façades. Installers can rely on our high quality solutions.

Experience built in as standard. We are able to draw on more than two decades of experience in the development of mounting systems. Our solutions have been used successfully since the 1990s and we have been constantly and consistently improving our knowledge since then. The pioneering novotegra mounting system in its current form was first created in 2006, and has been proving itself on roofs all over Europe for 15 years.

Not one single solution for all, but the right solution for everyone. We developed our mounting systems by collaborating closely with the installer. Besides working in the office and on the test bench, our developers can be found on-site wherever our products are used. At construction sites, we familiarise ourselves with the work carried out by installers — down to the very last detail. Thanks to this valuable practical experience, we have developed a flexible system that meets all our needs of the customers.



The perfect solution for every roof

Our photovoltaic mounting systems have performed successfully on the market for many years now – and worldwide.

A partnership-based working model. In addition to providing the perfect equipment, we also share our comprehensive know-how with the installer. We provide advice already in the planning stage of an installation. Anyone using novotegra for the first time will be supported by one of our installation experts, who will spend a whole day on the construction site and share a wealth of tips and tricks. And all that is free of charge. As the world of photovoltaics is constantly evolving, we ensure that our partners are always up-to-date with the very latest information in solar technology by attending specialist seminars, webinars and information events.

Uncompromising quality. At our company, development, technical service and purchasing go hand in hand to ensure that all components are tailored to our customers' needs. Since the highest quality is our top priority, we subject all our products to strict quality controls. Our customers can rely on only receiving precisely manufactured, durable and corrosion-resistant components. In addition, they benefit from short supply chains and can be sure that everything will arrive where it is needed, on time.

No empty promises of quality, just reliable certifications. All novotegra mounting systems are developed by our engineers at the company headquarters in Germany. To ensure they meet our high standards, the systems are subjected to extensive tests — both in our in-house test laboratories and at independent institutes. In addition to certifications from TÜV Rheinland and building authority approvals, our mounting systems have been awarded the CE mark, as well as ETN and MSC certifications for the French and British markets. As we are convinced of the reliability and high quality of our products, we offer our customers a 12-year guarantee on our mounting systems.

Sustainability is our key goal. That is why novotegra system parts are extremely durable. If they do need to be replaced at some point after a very long period of use, they can be fully recycled. We also think it is important that our suppliers use renewable energies in their production. For us, however, sustainable action is not simply limited to the environment. We are equally committed to society. As such, we have been working with non-profit workshops and organizations in Baden-Württemberg for many years. Here, people with disabilities or mental illness are given the opportunity to work.



We do a lot to ensure the success of our customers. High-quality products and optimal service are crucial here.

Thomas Pfaff, Managing Director

Mounting system layout with Solar-Planit

Simple, clear, free of charge and web-based planning for your next installation. Solar-Planit lets you keep control of costs and statics.

PV systems planned with Solar-Planit:

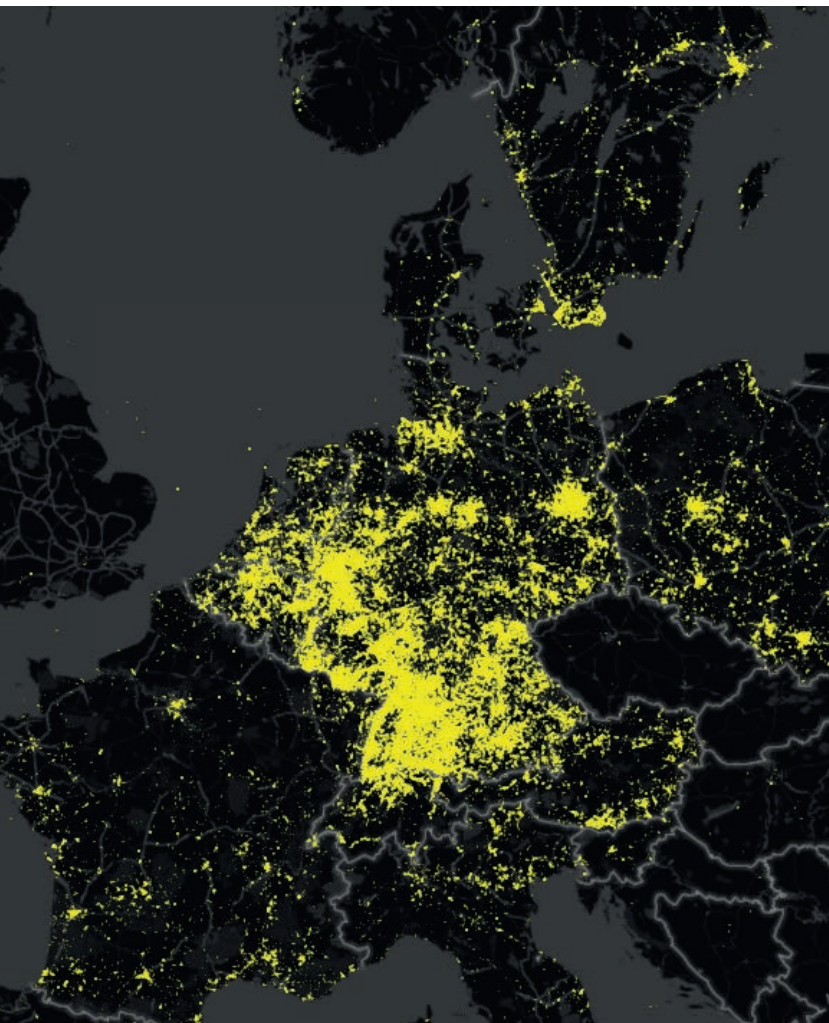

Germany



French-Martinique



French-Guadeloupe



Réunion (F)

Your project

- Define location and roof features individually for your project
- Select module and mounting system design – from tile roof to flat roof
- Plan the module configuration – easily plan around chimneys, skylights and dormers
- Perform a structural analysis and optimise the system – in line with the Eurocode standard for many European countries
- Benefit from automatized transfer of material parts list to the web shop

All in one: complete system planning with Solar-Planit

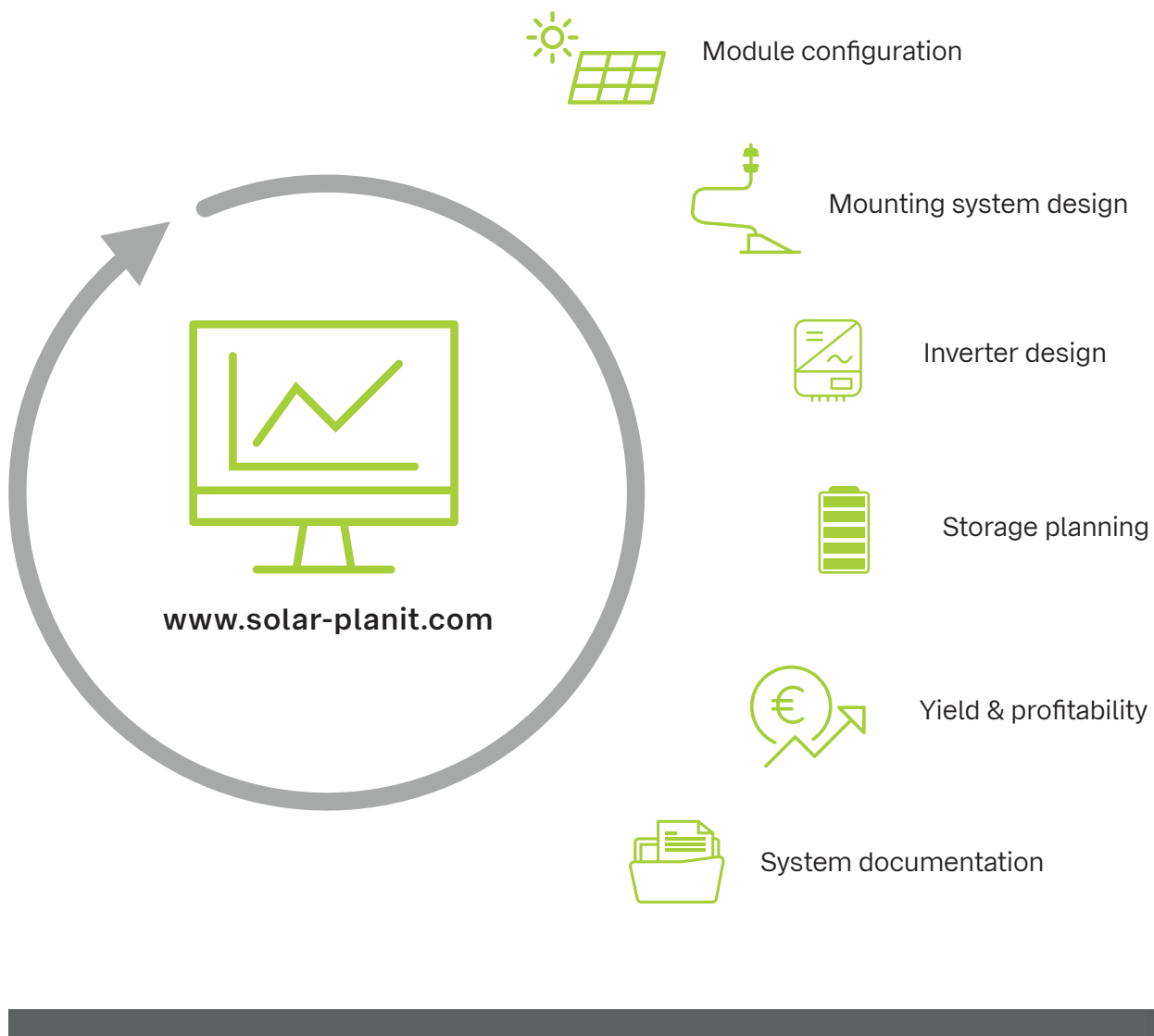

Your result

- complete overview of the structural analysis, material requirements and costs
- System project reports – documentation for you and your customers by just pushing one button
- Independent and self-contained planning – this web-based solution makes short administrative paths possible for project collaboration either with your team or with our sales team

Your benefits

- Complete system planning, from installation to economic – always up to date
- Free and web-based
- Static calculation according to Eurocode
- Determination of yield, profitability and own consumption ratio
- Free webinars on how to use Solar-Planit

We are there where our customers need us

Sales are handled by the BayWa r.e. trading companies throughout Europe. This means we are very close everywhere and provide local..

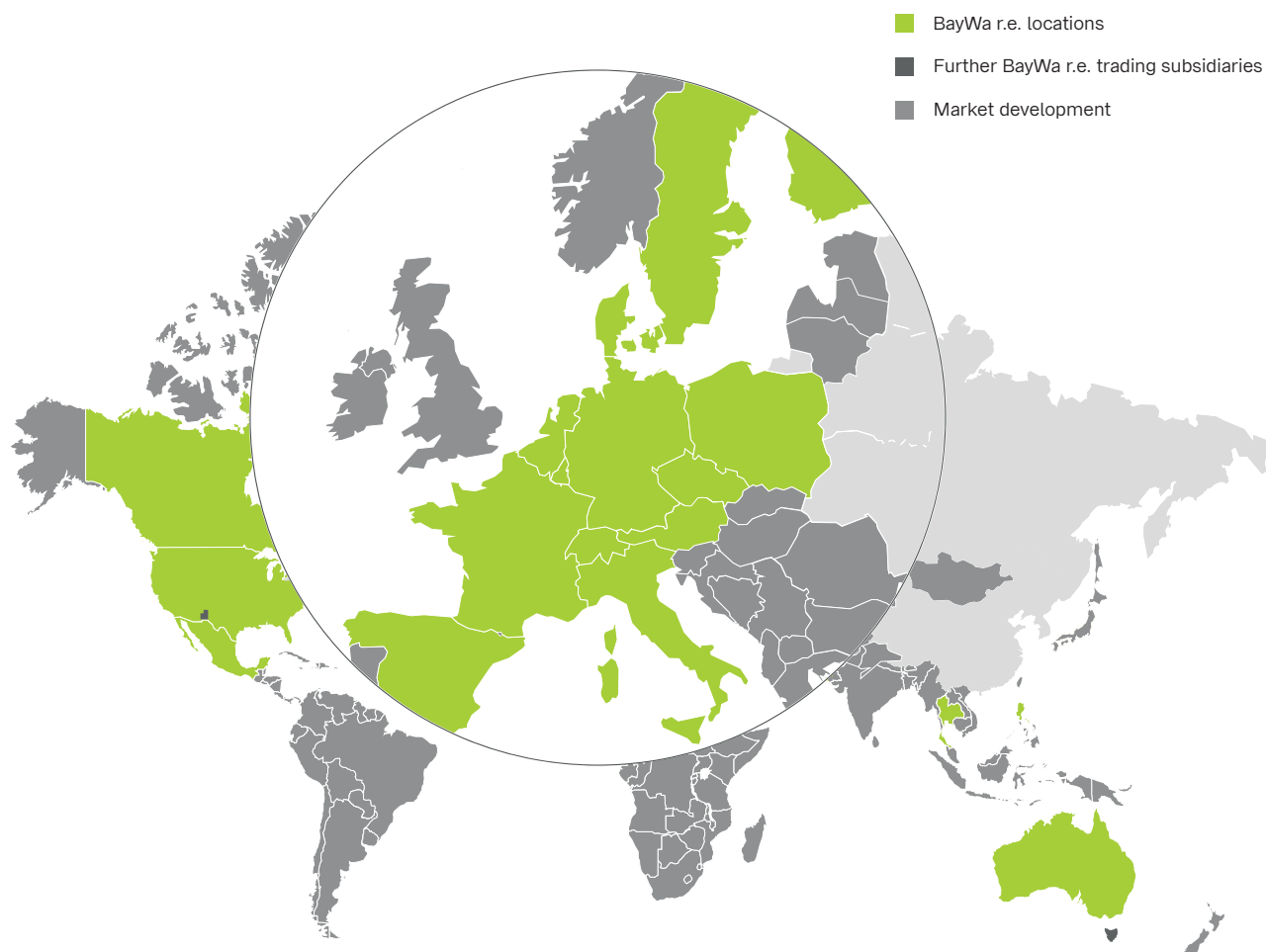

Exemplary availability. We offer our customers everything they need for assembling their installations. Our complete range is available in our wholesalers' warehouses throughout Europe and can be delivered fast. A comprehensive logistics network guarantees a very high availability of our components, even for less common roof types. By collaborating closely with forwarding agents that operate internationally, our sales partners ensure that all orders arrive promptly at the construction site.

Close by — everywhere. novotegra is where our customers are. Together with our sales partners, we have built up a Europe-wide network that acts as a direct link to our installation experts on-site. Whether you are in Scandinavia or in Southern Italy, whether you are in Spain or in Poland, our professional sales team is there to offer our customers advice and support.

Certifications and Approvals

novotegra stands for quality, high-end materials and reliable production. Together with our long-standing partners and independent institutes we ensure that this remains in the future.

CE marking

The in-house monitoring for the mounting system by novotegra GmbH meets all mandatory requirements stipulated in EN 1090-1:2009+A1:2011, Annex ZA as the foundation of the CE marking within the framework of the EU Regulation no. 305/2011 (Construction Product Regulation – CPR). Execution in accordance with EN 1090-2 and EN 1090-3, EXC1.



General approvals by the building authorities

For your safety, we had the static calculations of relevant parts of the system checked by independent authorities. We received the following general approvals from Deutsches Institut für Bautechnik (German Institute for Structural Engineering):

- Z-14.4-716: Connections for PV mounting systems
- Z-14.4-723: Rail connectors and base profile
- Z-14.4-735: Module attachments, module supports, cross rail connectors
- Z-14.4-741: Roof hooks, stock screws, attachments to the rail base



TÜV Rheinland certification

The reliability and quality of our mounting system has been certified with the TÜV Rheinland test mark.

The inspection catalogue for the certification includes all building law and technical requirements that mounting systems must meet. This ensures that all our photovoltaic mounting systems are produced in the same way as the tested systems – with the same materials and processes and thus with the same quality.

By the way: our sales and support services also convinced the auditors.



Structural analysis calculation with Solar-Planit

With our planning tool Solar-Planit, you can see the system structural analysis of our mounting system at the push of a button – and for free! The load determination for the structural analysis of the substructure is based on the specifications of Eurocode 1. The only exception is Switzerland, where load is determined according to SIA 261 (2003) specifications.















Information on further international certificates can be obtained from your contact person.



1

Pitched roof

Mounting system overview pitched roof

	 Tile and beavertail roof	 Corrugated and sandwich roof
Modules portrait and landscape  Modules portrait and landscape	Roof hook ZD 30 N35  Roof hook ZD 533  Roof hook ZD 544  Roof hook ZD  Roof hook flex  Roof hook BS 	Stock screw for wood  Stock screw for steel 
Profile rail  C-N-rail 37  C-rail in blank or black  C38-1.6  C47-2  C71-2  C95-3 		
Module attachment  Clamping and insertion system in black and blank 		

Mounting system overview pitched roof

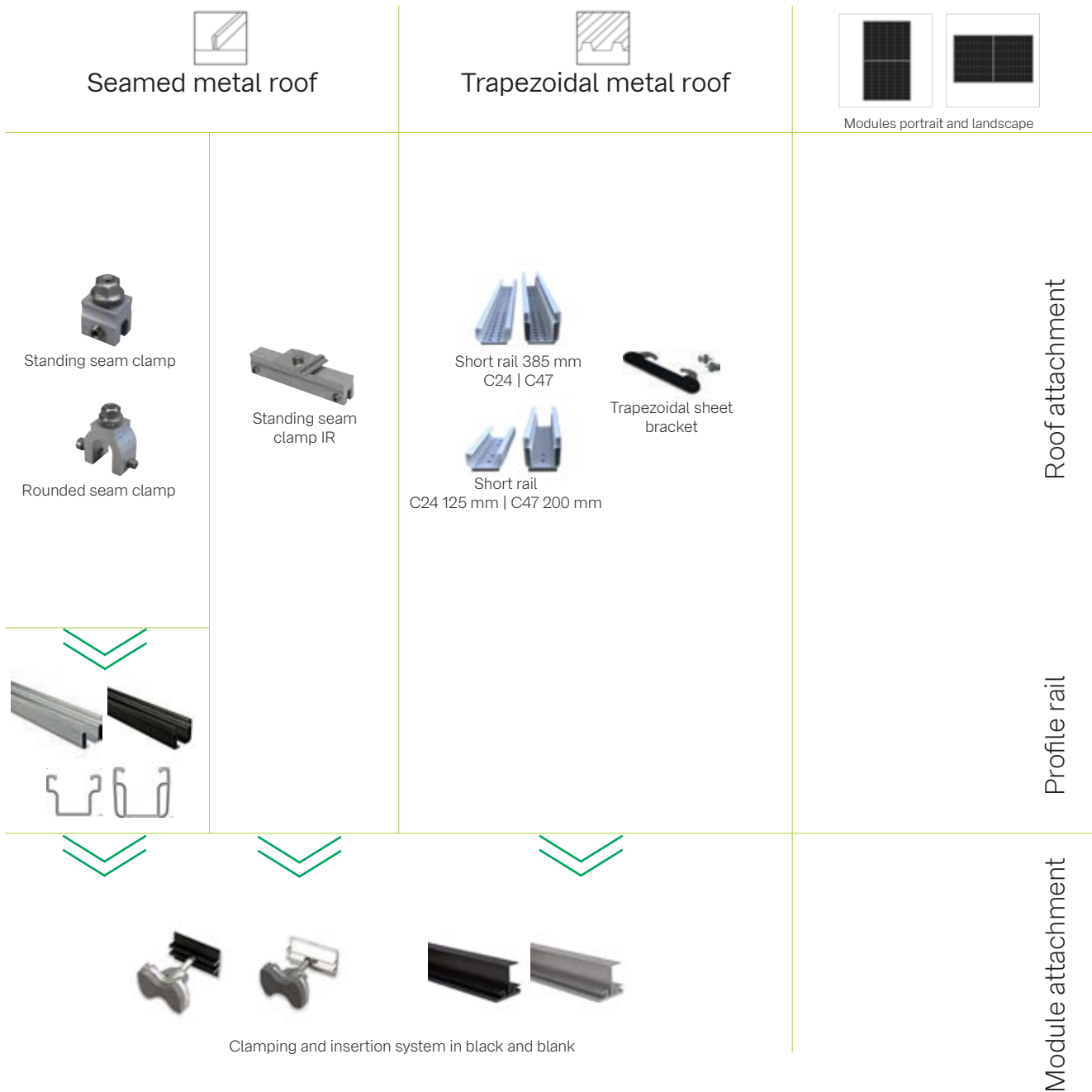

Tile roof | clamping system top-fix

Clamping system with modules installed in portrait

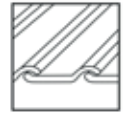

Powerful, stable and flexible

- components usable across different roof types
- module landscape installation possible with cross layer system
- only two clamps for all frame heights in blank and black anodized

product variants

- flex roof hook for low loads
- roof hook versions for 40mm battens available
- double roof hooks for heavy loads
- rails and clamps available in blank and black anodized

Your benefits

- three-way adjustable roof hook to level out uneven roofs, for different tile strengths and shapes
- quick mounting from above with easily graspable components
- narrow tile gap and centric load distribution
- the C-rail also acts as a cable channel



Double roof hooks for heavy snow loads



C47 S rail connectors for profile clammers

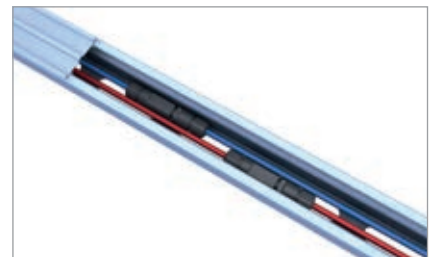

C-rail as cable channel

novotegra top-fix | clamping system

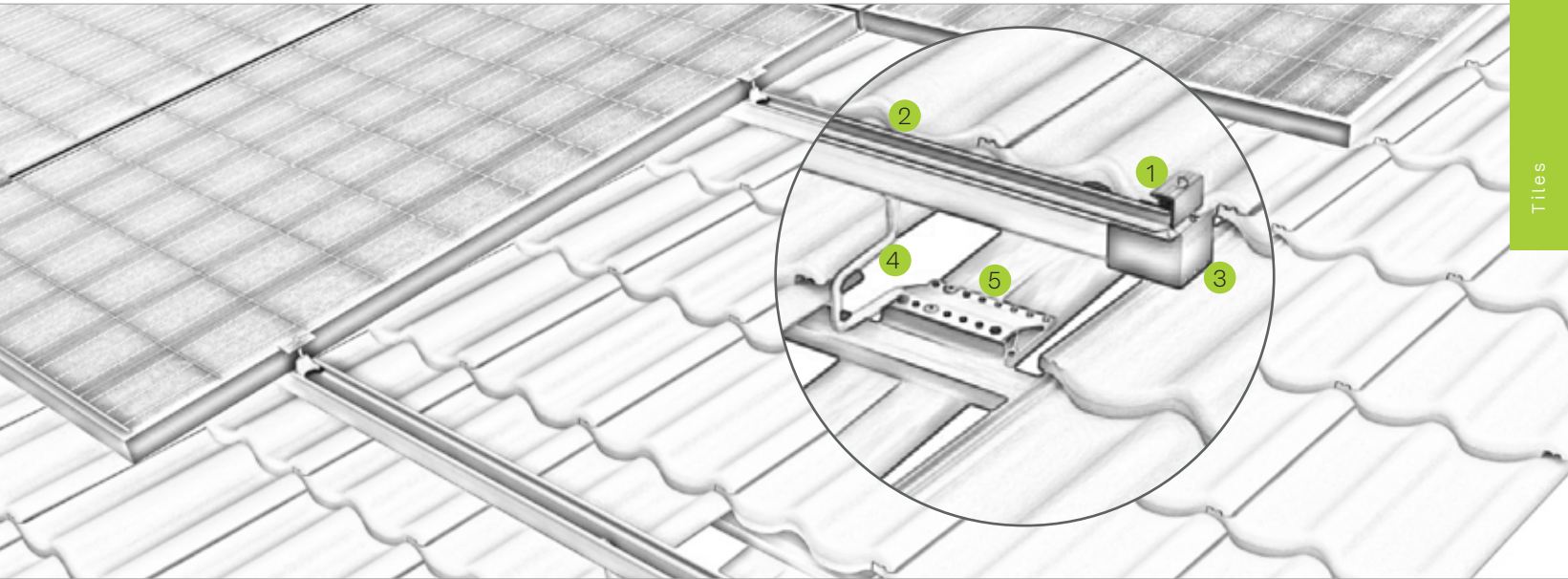

Pic Designation

- | | |
|---|---|
| ① | <p>Middle and end clamp</p> <ul style="list-style-type: none"> ▪ for frame heights of 30-42 mm and 43-52 mm ▪ installation-friendly thanks to click-in mechanism |
| ② | <p>C-rail</p> <ul style="list-style-type: none"> ▪ available in different strength and lengths ▪ can be stepped on throughout installation |
| ③ | <p>End cap</p> <ul style="list-style-type: none"> ▪ for optically tidy rail ends ▪ UV and weather resistant |
| ④ | <p>Roof hook</p> <ul style="list-style-type: none"> ▪ three-way adjustable for perfect installations ▪ various roof hooks for low and high load situations |
| ⑤ | <p>Screws</p> <ul style="list-style-type: none"> ▪ building authority-approved ▪ Ø 6 / 8 mm available in different lengths |



Light roof hooks for narrow rafters

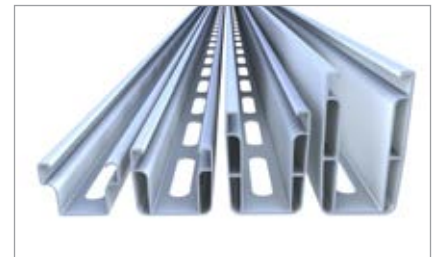

Variations of C-rail

Beavertail tile roof | clamping system top-fix

Clamping system on beavertail tile roofing with modules installed in portrait

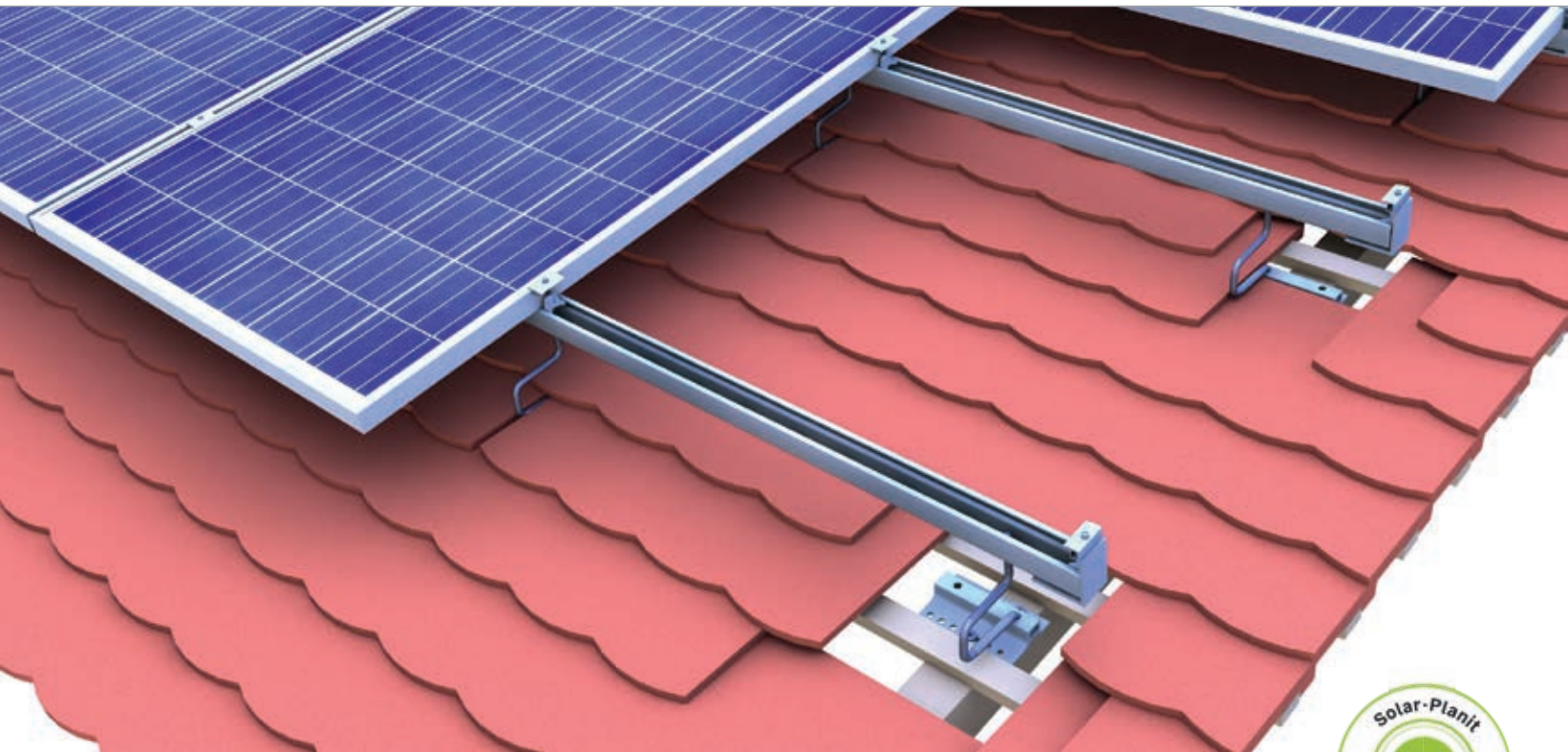
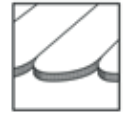

Solution for beavertail tiles

- components usable across different roof types
- module landscape installation possible with cross layer system
- only two clamps for all frame heights in blank and black anodized

product variants

- roof hook flex for lower loads or 40mm battens
- roof hook beavertail available also as double roof hook
- rails and clamps available in blank and black anodized

Your benefits

- three-way adjustable roof hook to level out uneven roofs, for different tile strenghts and shapes
- the C-rail also acts as a cable channel
- no beavertail sheet metal tile required
- narrow tile gap and centric load distribution



Position of the bracket with beavertail tiling



Rail connector C 47 S for profile chambers



Slip guard for fixing modules

novotegra top-fix | clamping system

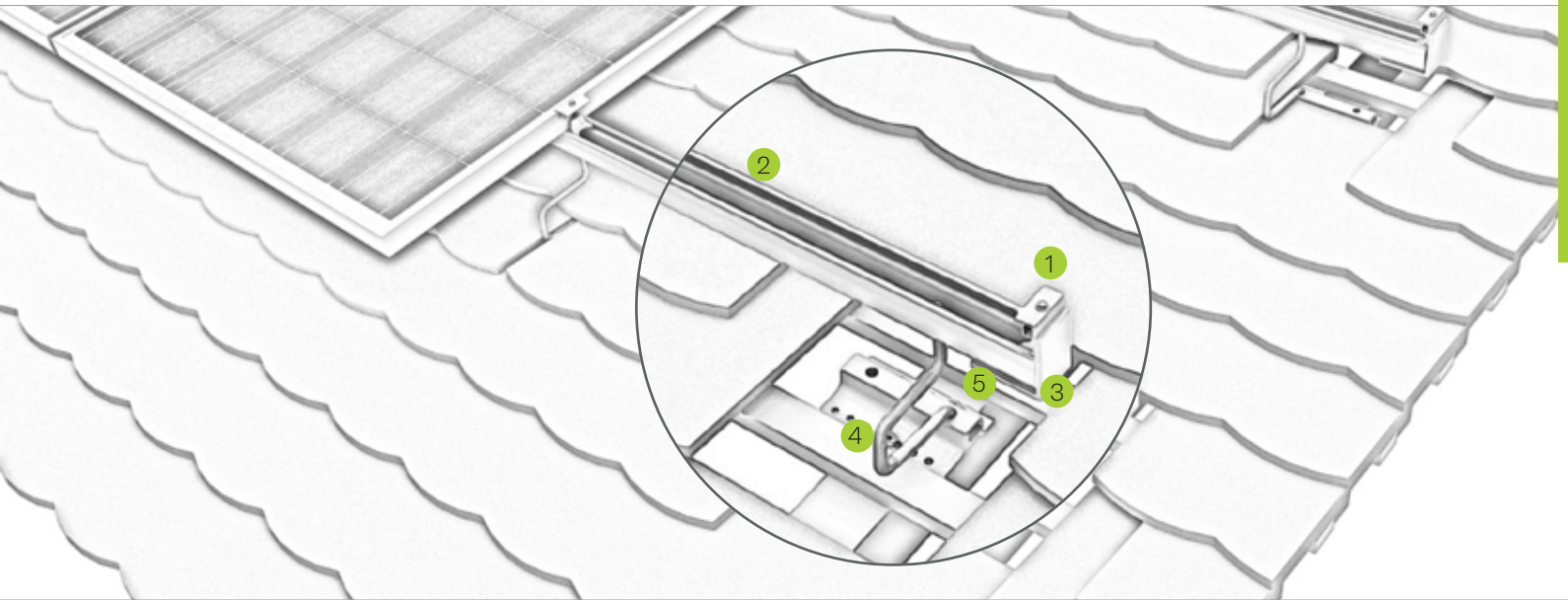

Pic Designation

- | | |
|---|---|
| 1 | <p>Middle and end clamp</p> <ul style="list-style-type: none"> ▪ for frame heights of 30-42 mm and 43-52 mm ▪ installation-friendly thanks to click-in mechanism |
| 2 | <p>C-rail</p> <ul style="list-style-type: none"> ▪ available in different strength and lengths ▪ can be stepped on throughout installation |
| 3 | <p>End cap</p> <ul style="list-style-type: none"> ▪ for optically tidy rail ends ▪ Slip guard for fixing modules mounted in landscape |
| 4 | <p>Roof hook</p> <ul style="list-style-type: none"> ▪ three-way adjustable for perfect installations ▪ various roof hooks for low and high load situations |
| 5 | <p>Screws</p> <ul style="list-style-type: none"> ▪ building authority-approved ▪ Ø 6 / 8 mm available in different lengths |



Light roof hooks for narrow rafters



Variations of C-rail

Tile roof | clamping system side-fix

Clamping system with modules installed in portrait

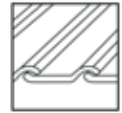

Quick and easy fixing

- module landscape installation possible with cross layer system
- wide base profile and lateral adjustability offer maximum flexibility throughout installation
- low substructure clearance to the roof coverage

product variants

- rails and clamps available in blank and black anodized

Your benefits

- quick roof hook installation through click technology
- roof hooks for large tile overlap up to approx. 11 cm
- easy to assemble connection from the side
- internal connector for maximum assembly freedom



Position of base profile on rafters



Connector C-N-rail 37



End clamp and end cap in C-N-rail

novotegra side-fix | clamping system

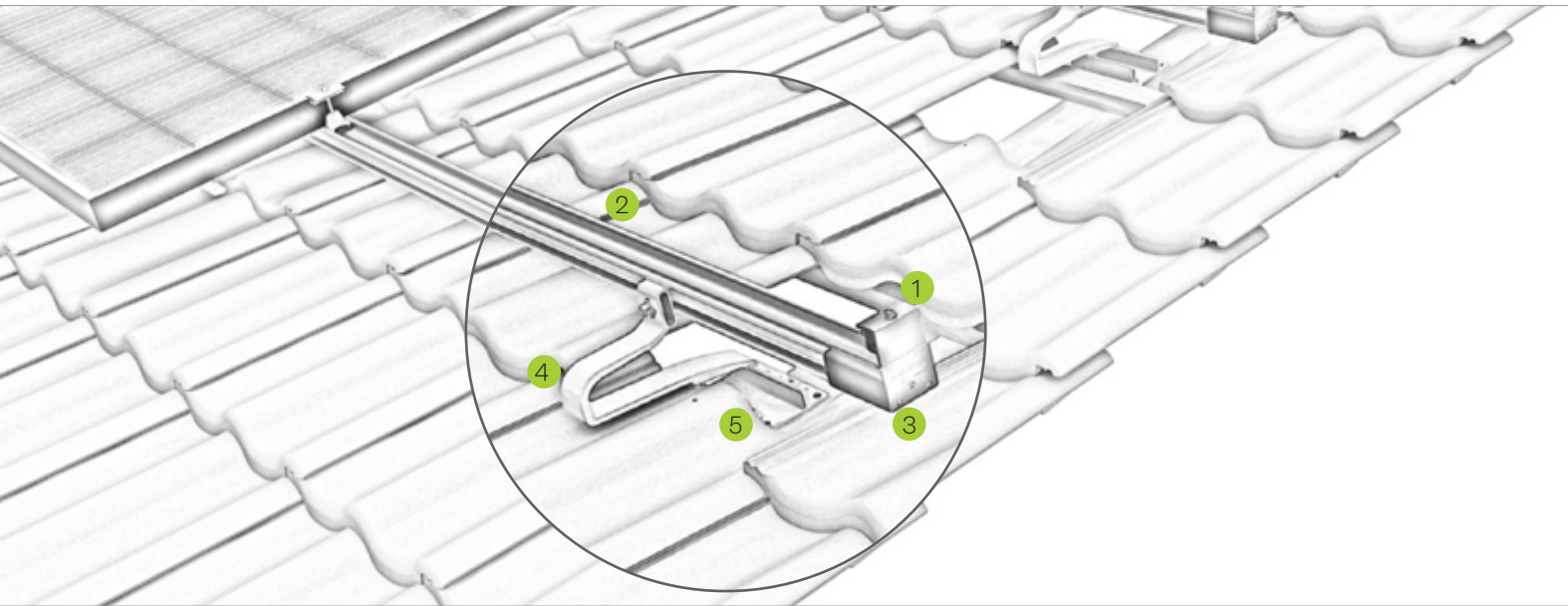

Pic Designation

- | | |
|---|--|
| 1 | Middle and end clamp <ul style="list-style-type: none"> ▪ for frame heights of 30-42 mm and 43-52 mm ▪ installation-friendly thanks to click-in mechanism |
| 2 | C-N-rail <ul style="list-style-type: none"> ▪ available in different lengths in blank and black ▪ can be stepped on throughout installation |
| 3 | End cap <ul style="list-style-type: none"> ▪ for optically tidy rail ends ▪ UV and weather resistant |
| 4 | Roof hook <ul style="list-style-type: none"> ▪ quick installation through click technology ▪ high stability thanks to centric load distribution |
| 5 | Screws <ul style="list-style-type: none"> ▪ building authority-approved ▪ Ø 6 / 8 mm available in different lengths |



Slip guard for fixing modules



C-N-rail as cable channel

Tile roof | insertion system top-fix

Insertion system with modules installed in portrait

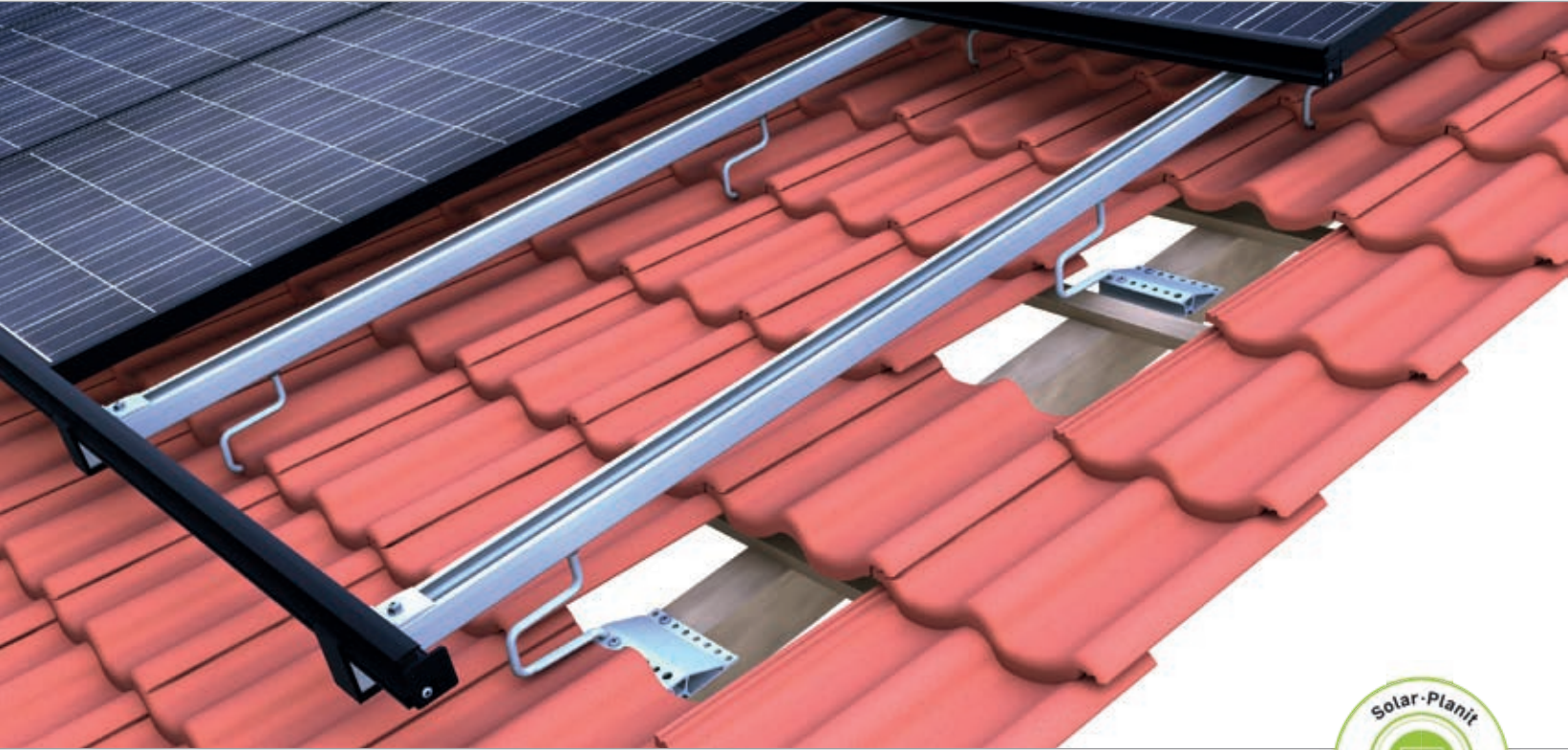
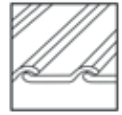

Position, insert – finished!

- components usable across different roof types
- narrow tile gap and centric load distribution
- mounting modules in portrait or in landscape
- insertion rail in blank and black anodized – color matching the module

product variants

- flex roof hook for low loads
- roof hook versions for 40mm battens available

Your benefits

- high-end installation aesthetics and time-efficient thanks to insertion technology
- three-way adjustable roof hook to level out uneven roofs, for different tile strengths and shapes
- tension-free and floating module mounting
- the C-rail also acts as a cable channel



Height-adjustable flex roof hook set



Rail connector insertion rail



Closing insertion rail and C-rail

novotegra top-fix | insertion system

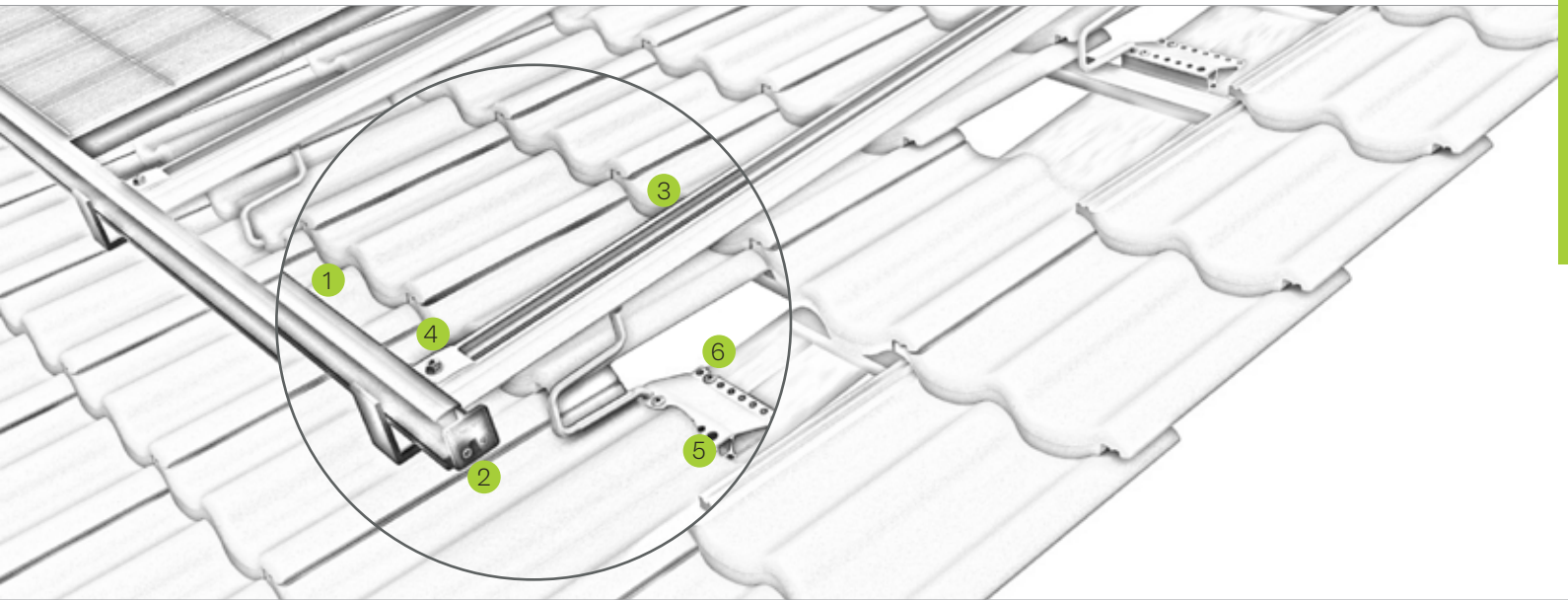

Pic Designation

- | | |
|---|--|
| ① | Insertion rail <ul style="list-style-type: none"> ▪ Insertion rails in blank/black anodized for frame heights ▪ tension-free and floating module mounting |
| ② | Edge stop <ul style="list-style-type: none"> ▪ color-coordinated with the insertion rail ▪ prevents modules from slipping out |
| ③ | C-rail <ul style="list-style-type: none"> ▪ available in different strength and lengths ▪ can be stepped on throughout installation |
| ④ | Cross-rail connector <ul style="list-style-type: none"> ▪ safe connection due to force and form closure ▪ completely pre-assembled |
| ⑤ | Roof hook <ul style="list-style-type: none"> ▪ three-way adjustable for perfect installations ▪ various roof hooks for low and high load situations |
| ⑥ | Screws <ul style="list-style-type: none"> ▪ building authority-approved ▪ Ø 6 / 8 mm available in different lengths |



Light roof hooks for narrow rafters



Variations of C-rail

Beavertail tile roof | insertion system top-fix

Insertion system on beavertail tile roofing with modules installed in portrait

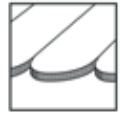

Classic meets modern – beavertail with insertion system

- components usable across different roof types
- narrow tile gap and centric load distribution
- mounting modules in portrait or in landscape
- insertion rail in blank and black anodized – color matching the module

product variants

- roof hook flex for lower loads or 40mm battens

Your benefits

- high-end installation aesthetics and time-efficient thanks to insertion technology
- three-way adjustable roof hook to level out uneven roofs, for different tile strenghts and shapes
- tension-free and floating module mounting
- no beavertail sheet metal tile required



Position of base profile BS on rafters



Closing insertion rail and C-rail



Rail connector insertion rail

novotegra top-fix | insertion system

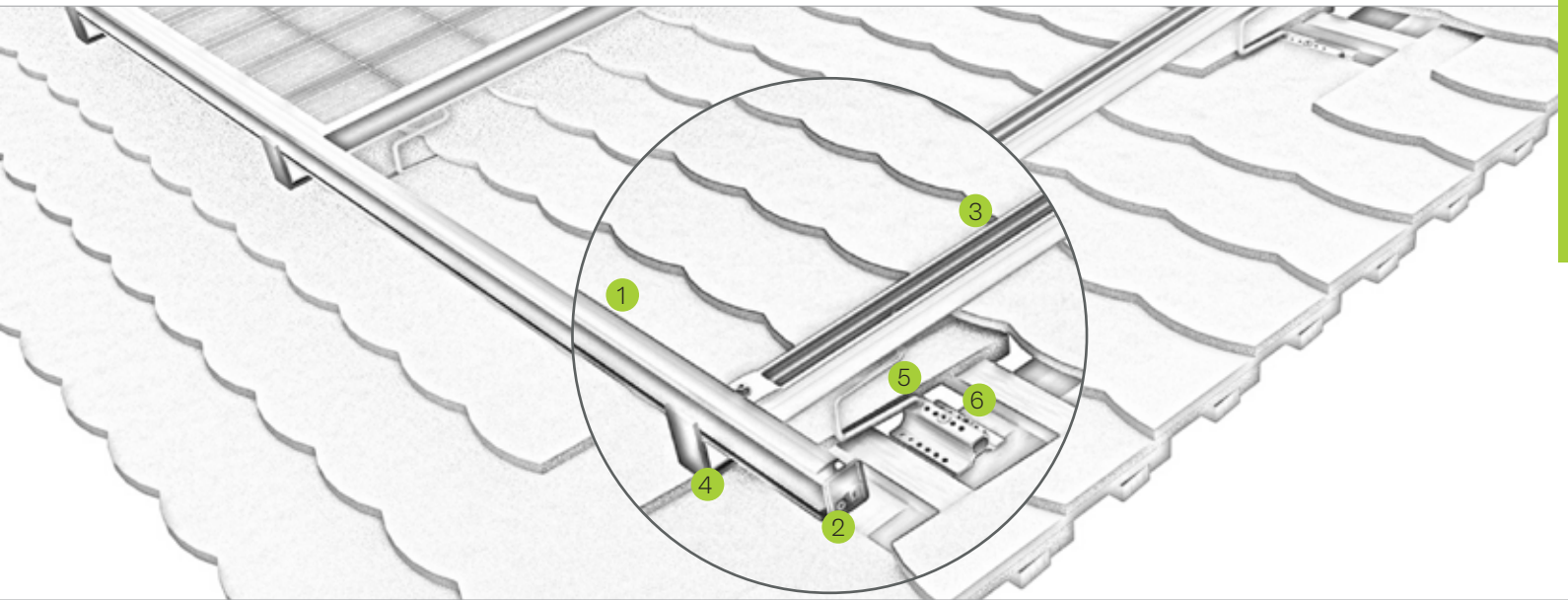

Pic Designation

- | | |
|---|--|
| ① | Insertion rail <ul style="list-style-type: none"> ▪ insertion rails in blank/black anodized for frame heights ▪ tension-free and floating module mounting |
| ② | Edge stop <ul style="list-style-type: none"> ▪ color-coordinated with the insertion rail ▪ prevents modules from slipping out |
| ③ | C-rail <ul style="list-style-type: none"> ▪ available in different strength and lengths ▪ can be stepped on throughout installation |
| ④ | Cross-rail connector <ul style="list-style-type: none"> ▪ safe connection due to force and form closure ▪ completely pre-assembled |
| ⑤ | Roof hook <ul style="list-style-type: none"> ▪ three-way adjustable for perfect installations ▪ various roof hooks for low and high load situations |
| ⑥ | Screws <ul style="list-style-type: none"> ▪ building authority-approved ▪ Ø 6 / 8 mm available in different lengths |



Light roof hooks for narrow rafters



Variations of C-rail

Tile roof | insertion system side-fix

Insertion system with modules installed in portrait

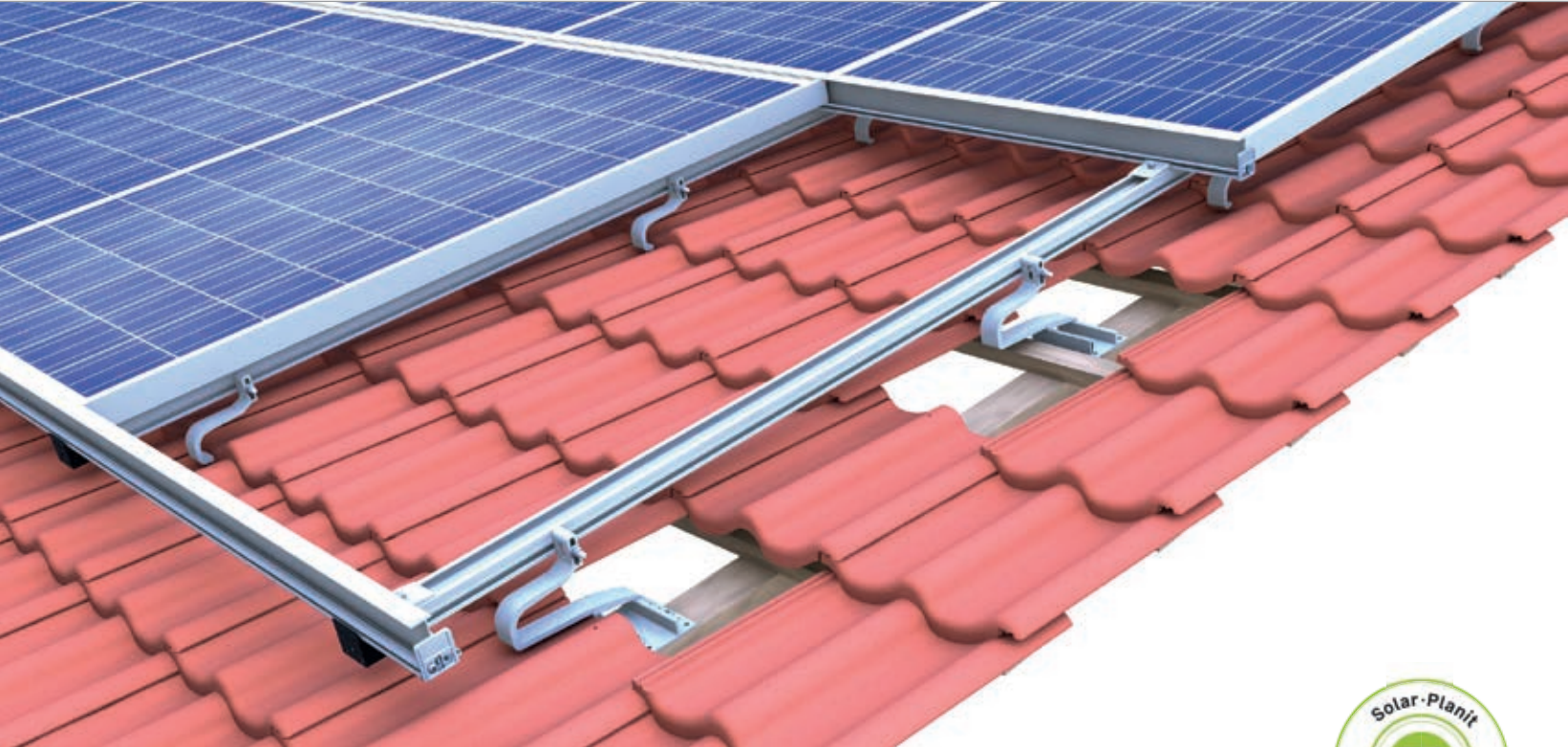
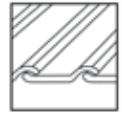

Proven and attractive

- mounting modules in portrait or in landscape
- easy to assemble connection from the side
- the C-N-rail also acts as a cable channel
- low substructure clearance to the roof coverage

product variants

- both C-N and N rail can be used as module support rail

Your benefits

- quick roof hook installation through click technology
- high-end installation aesthetics and time-efficient thanks to insertion technology
- roof hooks for large tile overlap up to approx. 11 cm
- tension-free and floating module mounting
- internal connector for maximum assembly freedom



Position of base profile on rafters

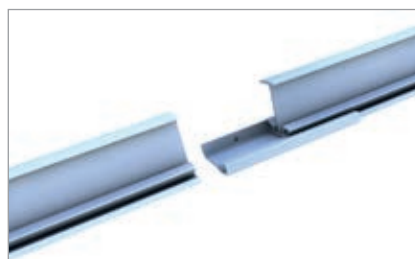

Rail connector insertion rail



Insertion rail on C-N-rail

novotegra side-fix | insertion system

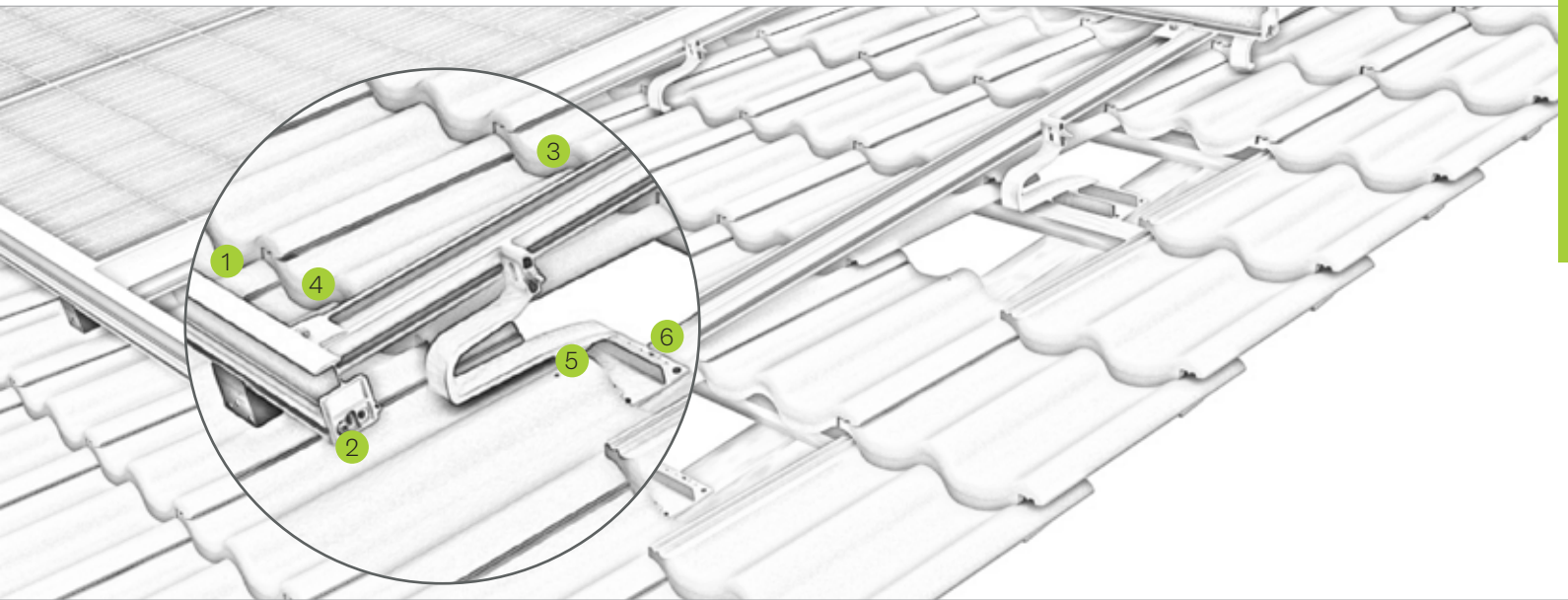

Pic Designation

- | | |
|---|--|
| ① | Insertion rail <ul style="list-style-type: none"> ▪ insertion rails in blank/black anodized for frame heights ▪ tension-free and floating module mounting |
| ② | Edge stop <ul style="list-style-type: none"> ▪ color-coordinated with the insertion rail ▪ prevents modules from slipping out |
| ③ | C-N-rail <ul style="list-style-type: none"> ▪ available in different lengths in blank and black ▪ can be stepped on throughout installation |
| ④ | Cross-rail connector <ul style="list-style-type: none"> ▪ safe connection due to force and form closure ▪ completely pre-assembled |
| ⑤ | Roof hook <ul style="list-style-type: none"> ▪ quick installation through click technology ▪ high stability thanks to centric load distribution |
| ⑥ | Screws <ul style="list-style-type: none"> ▪ building authority-approved ▪ Ø 6 / 8 mm available in different lengths |



Connector C-N-rail 37



C-N-rail as cable channel

Tile roof | insertion system side-fix

Insertion system with modules installed in portrait

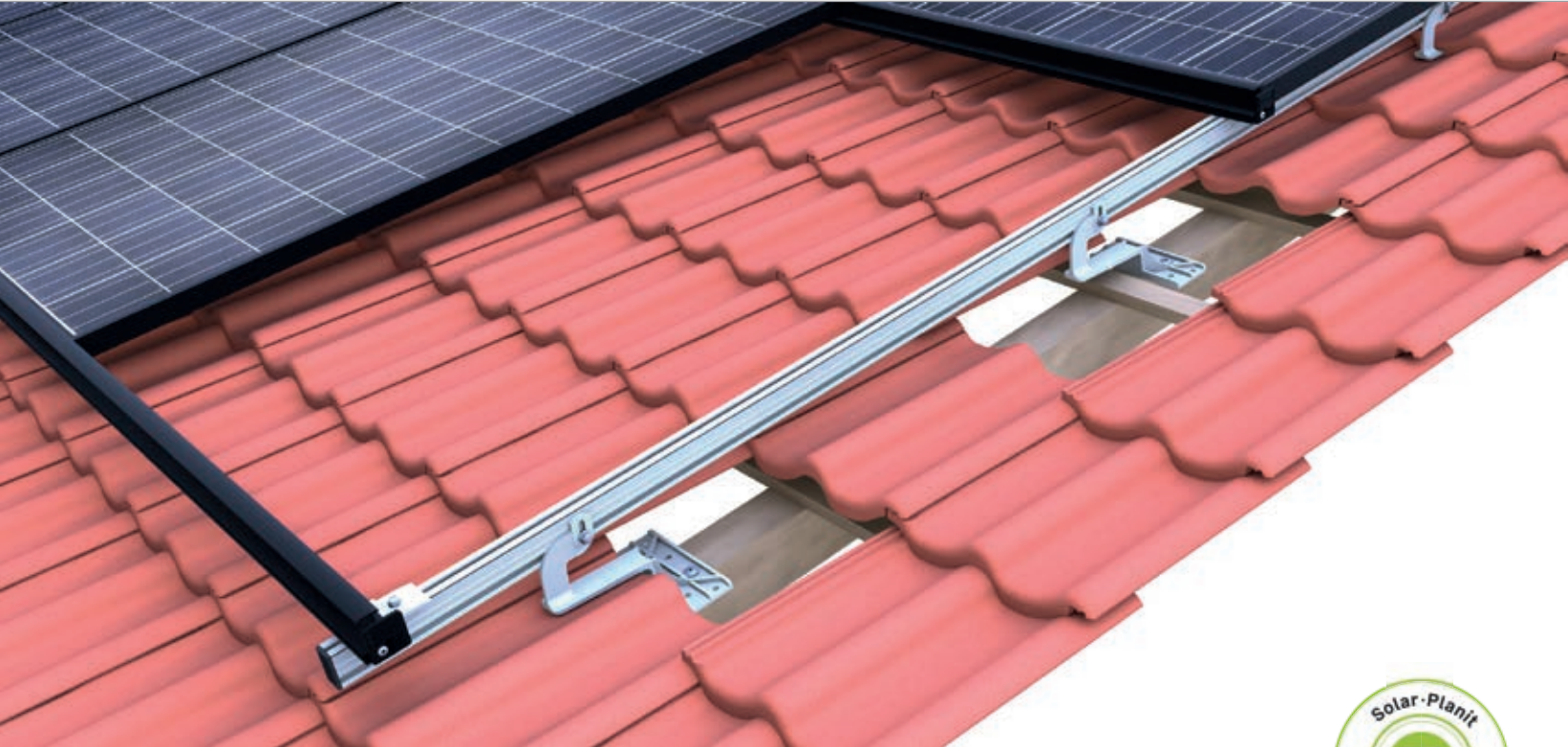
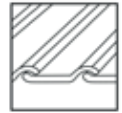

Proven and attractive

- mounting modules in portrait or in landscape
- easy to assemble connection from the side
- insertion rail in blank and black anodized – color matching the module
- low substructure clearance to the roof coverage

product variants

- both C-N and N rail can be used as module support rail
- roof hook available in height-adjustable version ZD 633

Your benefits

- high-end installation aesthetics and time-efficient thanks to insertion technology
- die-cast aluminium roof hooks without a welding seam
- tension-free and floating module mounting
- internal connector for maximum assembly freedom



Roof hook with height-adjustment N-rail



Rail connector insertion rail



Insertion rail on N-rail

novotegra side-fix | insertion system

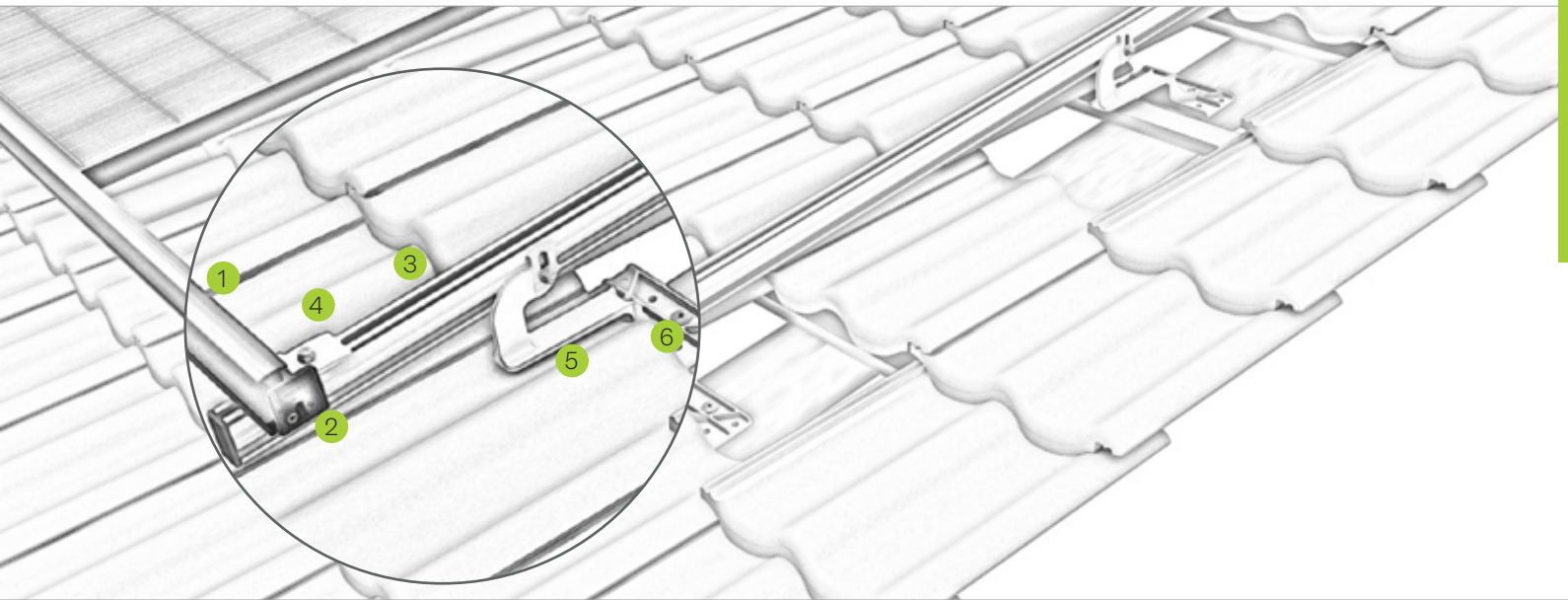

Pic Designation

- | | |
|---|--|
| 1 | Insertion rail <ul style="list-style-type: none"> ▪ insertion rails in blank/black anodized for frame heights ▪ tension-free and floating module mounting |
| 2 | Edge stop <ul style="list-style-type: none"> ▪ color-coordinated with the insertion rail ▪ prevents modules from slipping out |
| 3 | N-rail <ul style="list-style-type: none"> ▪ available in different strengths ▪ side groove with fluting |
| 4 | Cross-rail connector <ul style="list-style-type: none"> ▪ safe connection due to force and form closure ▪ completely pre-assembled |
| 5 | Roof hook <ul style="list-style-type: none"> ▪ connection rail-roof hook height adjustable ▪ shims available for height compensation |
| 6 | Screws <ul style="list-style-type: none"> ▪ building authority-approved ▪ Ø 6 / 8 mm available in different lengths |



Connector N-rail

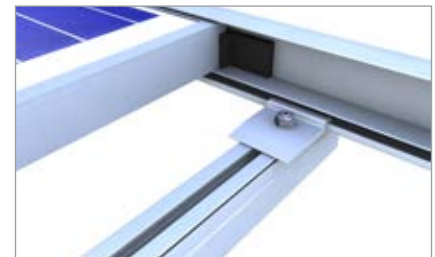

Cross-rail connector and EPDM-T protection

Mounting solutions for tile roof



novotegra top-fix 

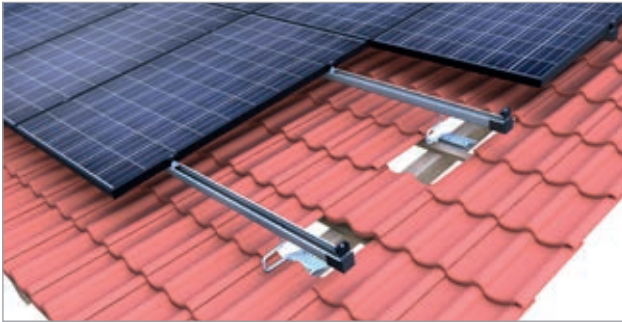

Clamping system: Single-rail in portrait



Clamping system: Single-rail in portrait on beavertail tiles



Clamping system: Cross-rail in landscape

Your benefits

- clamping and insertion systems for mounting modules in portrait and in landscape
- multiply adjustable roof hooks – unique design
- rail with an integrated cable channel and room for plugs
- quick mounting from above with easily graspable components



Insertion system: In portrait



Insertion system: In portrait on beavertail tiles



Insertion system: In landscape



Mounting solutions for tile roof

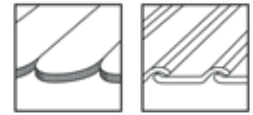

novotegra side-fix



Insertion system: In portrait



Clamping system: Single-rail in portrait



Insertion system: In portrait



Clamping system: Cross-rail in landscape

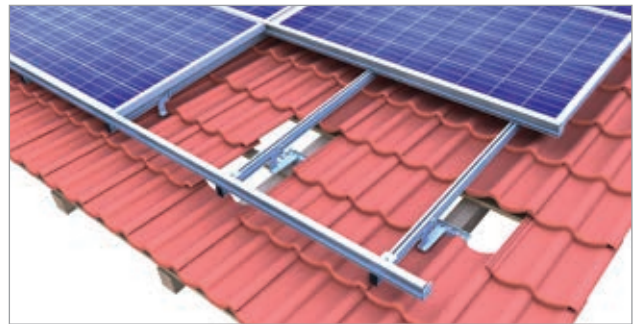

Insertion system: In landscape



Clamping system: Cross-rail in portrait

Your benefits

- clamping and insertion systems for mounting modules in portrait and in landscape
- low substructure clearance to the roof coverage
- mounting the rail from the side with view on the mounting spot

Trapezoidal metal roof | clamping system

Clamping system with direct fixing and modules installed in landscape

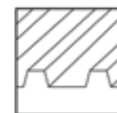

Pre-assembled components – quick assembly

- most cost effective mounting option on trapezoidal roof
- reduced logistical effort on the roof
- quick and efficient mounting from above
- electrically conductive connection between the mounting system and the roof membrane

product variants

- short rail C24 for the yield-optimised installation or the project business
- short rail C47 for excellent module rear ventilation with extra space to the roof covering

Your benefits

- only a handful of components, entirely pre-assembled
- low material costs and easy handling
- high holding forces thanks to chipless direct fixing with building authority-approved thin sheet screws
- only one mounting tool necessary



Short rail variations with EPDM seal

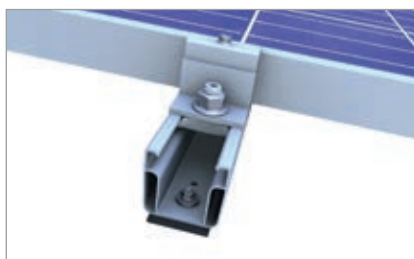

Slip guard on short rail for landscape



Hole pattern short rail for landscape

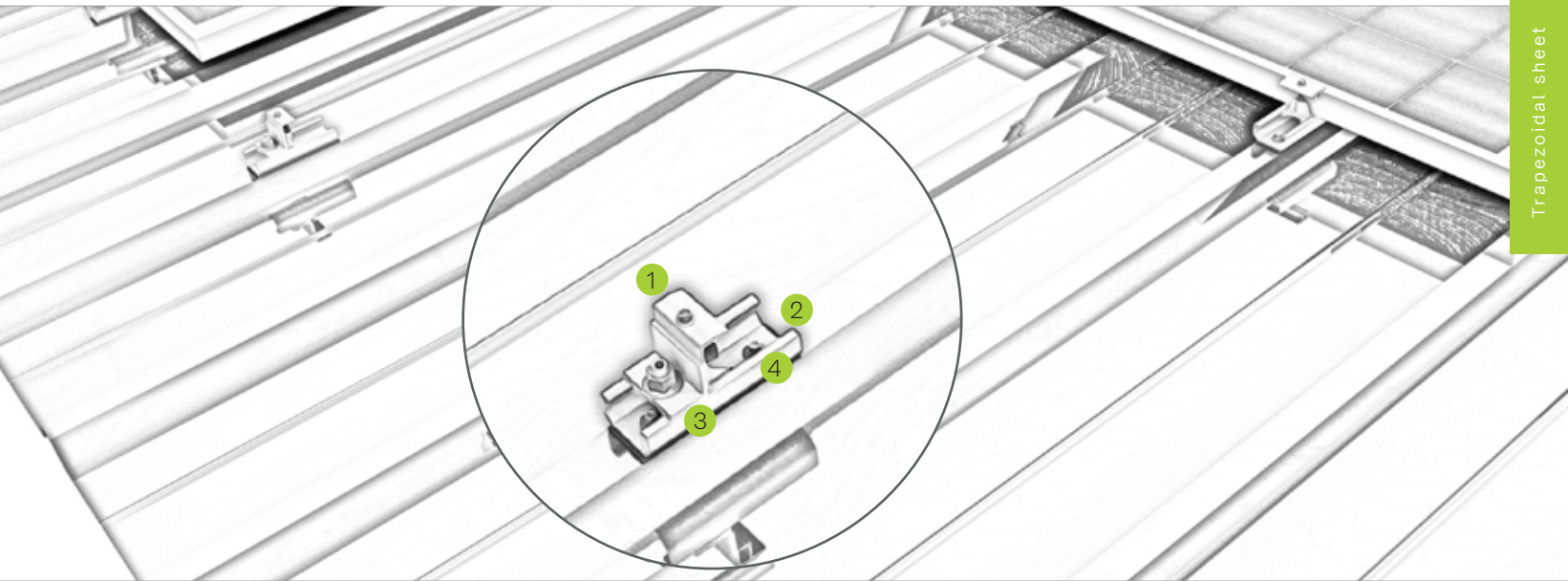

Pic Designation

- | | |
|---|---|
| 1 | <p>Middle and end clamp</p> <ul style="list-style-type: none"> ▪ for frame heights of 30-42 mm and 43-52 mm ▪ available in blank and black anodized |
| 2 | <p>Short rail</p> <ul style="list-style-type: none"> ▪ material-saving fixation on the raised bead ▪ entirely pre-assembled with EPDM-sealing and perforations |
| 3 | <p>Slip guard</p> <ul style="list-style-type: none"> ▪ mounting aid for the lowest module row ▪ additional securing of modules |
| 4 | <p>Mounting screw</p> <ul style="list-style-type: none"> ▪ building authority-approved for chipless direct fixing ▪ high holding forces thanks to funnel formation |



Short rail C 33 for corrugated metal sheets

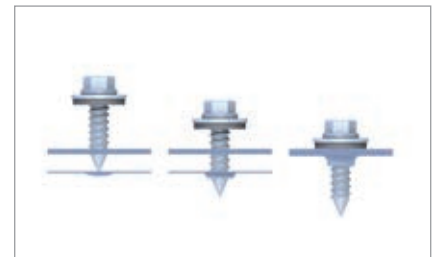

Chipless screwing for high holding forces

Trapezoidal metal roof | clamping system

Clamping system with direct fixing and modules installed in portrait

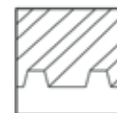

Vertical module installation – always the right solution

- module clamping in the optimum clamping range
- reduced logistical effort on the roof
- quick and efficient mounting from above
- electrically conductive connection between the mounting system and the roof membrane

product variants

- short rail C24 for the yield-optimised installation or the project business
- short rail C47 for excellent module rear ventilation with extra space to the roof covering
- optional mounting with C-rail pieces, suitable for roofs with low load reserve, C-rail acts as cable channel

Your benefits

- only a handful of components, entirely pre-assembled
- low material costs and easy handling
- high holding forces thanks to chipless direct fixing with building authority-approved thin sheet screws
- only one mounting tool necessary

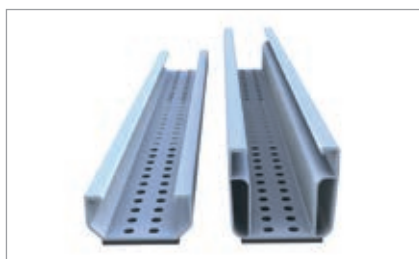

Versions of short rail 385 mm with EPDM seal



Hole pattern short rail for portrait

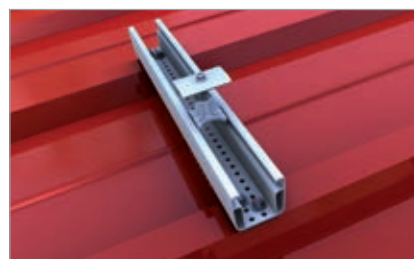

Middle clamp in short rail C47

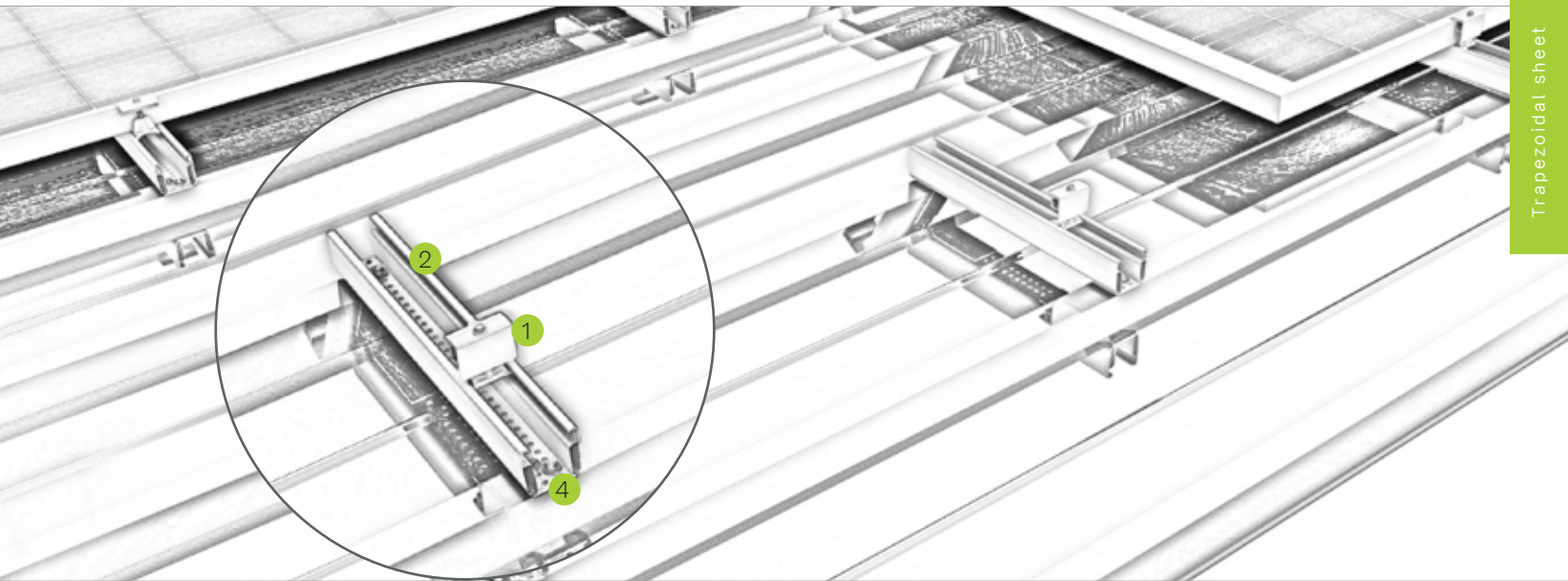

Pic Designation

- | | |
|---|--|
| ① | Middle and end clamp <ul style="list-style-type: none"> ▪ for frame heights of 30-42 mm and 43-52 mm ▪ available in blank and black anodized |
| ② | Short rail <ul style="list-style-type: none"> ▪ material-saving fixation on the raised bead ▪ entirely pre-assembled with EPDM-sealing and perforations |
| ③ | Slip guard <ul style="list-style-type: none"> ▪ for fixing modules with mounting holes 6-10 mm for mounting modules in portrait |
| ④ | Mounting screw <ul style="list-style-type: none"> ▪ building authority-approved for chipless direct fixing ▪ high holding forces thanks to funnel formation |

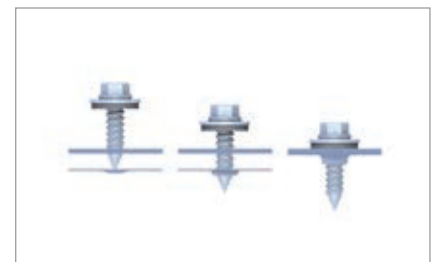

Chipless screwing for high holding forces

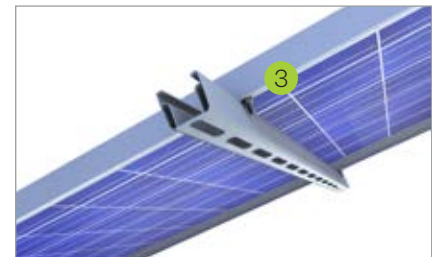

Slip guard for fixing modules

Trapezoidal metal roof | insertion system

Insertion system with direct fixing and modules installed in portrait

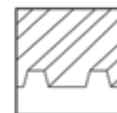

Combined – insertion rails on short rail

- components usable across different roof types
- excellent rear ventilation of the module
- mounting modules in portrait or in landscape

product variants

- short rail C24 for the yield-optimised installation
- short rail C47 for excellent module rear ventilation with extra space to the roof covering
- insertion rail in blank and black anodized – color matching the module

Your benefits

- only a handful of components – quick assembly
- high-end installation aesthetics and time-efficient mounting thanks to insertion technology
- high holding forces thanks to chipless direct fixing with building authority-approved thin sheet screws
- tension-free and floating module mounting



Short rail variations with EPDM seal

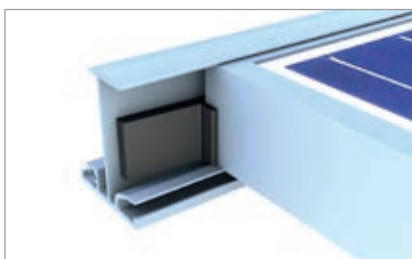

Module security at low roof inclination



Insertion rail attached to short rail

novotegra top-fix | insertion system

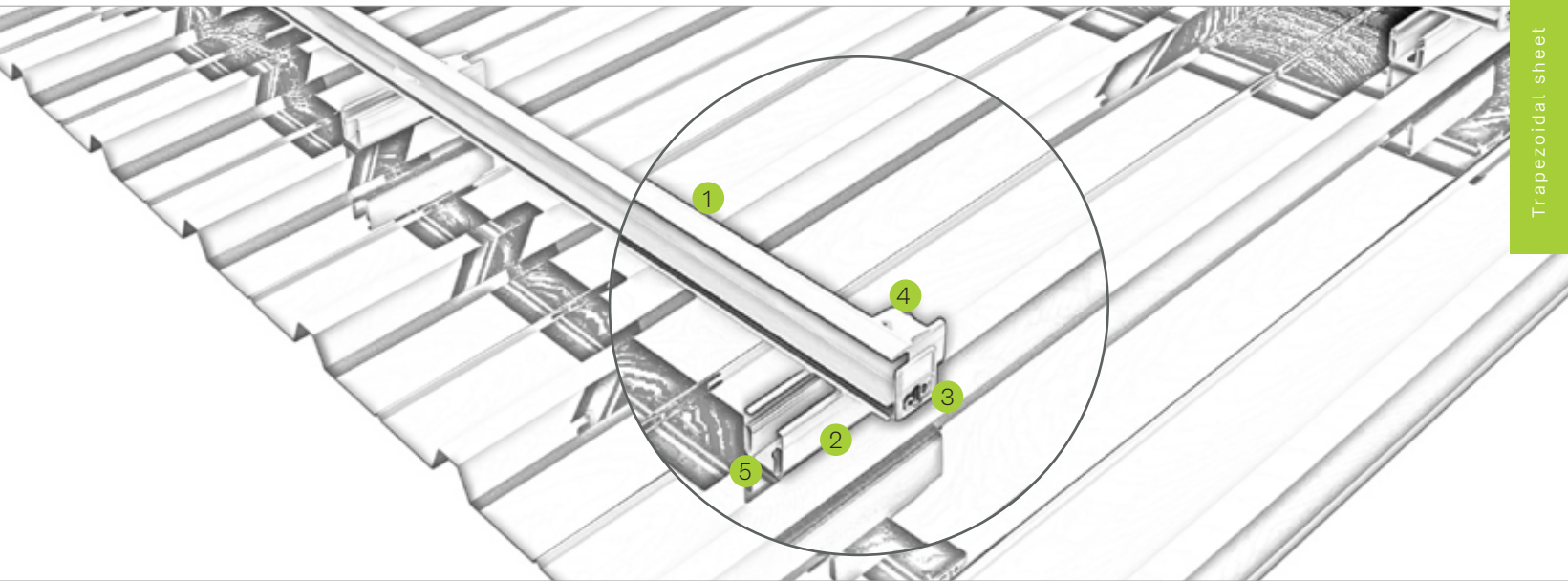

Pic Designation

-
- ① **Insertion rail**
- insertion rails in blank/black anodized for frame heights
 - tension-free and floating module mounting
-
- ② **Short rail**
- material-saving fixation on the raised bead
 - entirely pre-assembled with EPDM-sealing and perforations
-
- ③ **Edge stop**
- color-coordinated with the insertion rail
 - prevents modules from slipping out
-
- ④ **Cross-rail connector**
- safe connection due to force and form closure
 - completely pre-assembled
-
- ⑤ **Mounting screw**
- building authority-approved for chipless direct fixing
 - high holding forces thanks to funnel formation
-

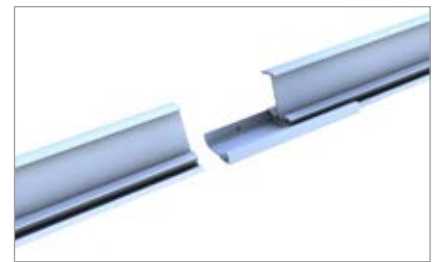

Connecting insertion rails

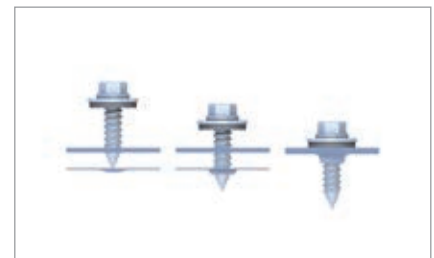

Chipless screwing for high holding forces

Trapezoidal metal roof | insertion system

Insertion system with direct fixing and modules installed in portrait

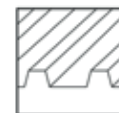

Convincing quality for your trapezoidal roof

- only a handful of components – quick assembly
- mounting modules in portrait or in landscape
- insertion rail is fixed directly to the trapezoidal sheet via trapezoidal sheet bracket

product variants

- insertion rail in blank and black anodized in different heights for all modules

Your benefits

- high-end installation aesthetics and time-efficient mounting thanks to insertion technology
- high holding forces thanks to chipless direct fixing with building authority-approved thin sheet screws
- tension-free and floating module mounting



Insertion rail on EPDM with trapezoidal bracket

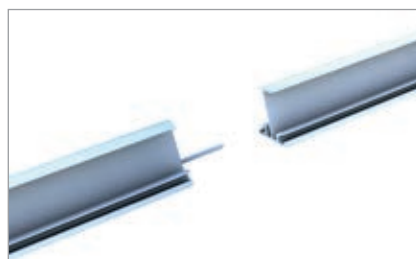

Insertion rail connection on trapezoidal sheet

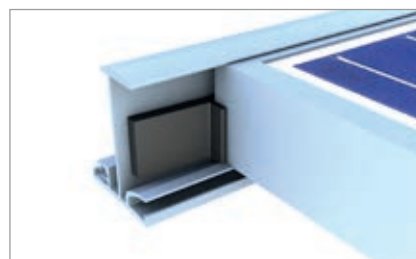

Module security at low roof inclination

novotegra | insertion system

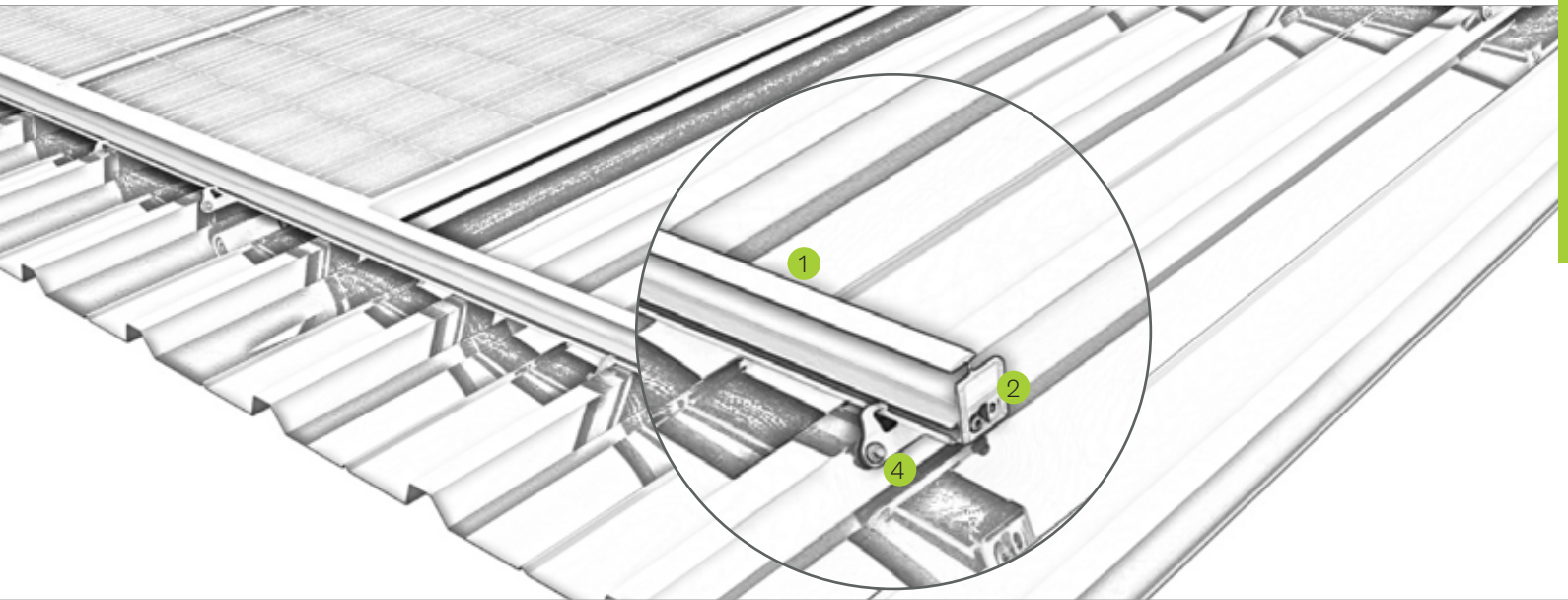

Pic Designation

- | | |
|---|--|
| ① | Insertion rail <ul style="list-style-type: none"> ▪ insertion rails in blank/black anodized for frame heights ▪ tension-free and floating module mounting |
| ② | Edge stop <ul style="list-style-type: none"> ▪ color-coordinated with the insertion rail ▪ prevents modules from slipping out |
| ③ | EPDM sealant strip <ul style="list-style-type: none"> ▪ protection and sealing layer at the same time ▪ Resistant to weathering |
| ④ | Roof attachment <ul style="list-style-type: none"> ▪ bracket with EPDM seal for fixing insertion rails ▪ chipless screwing due to thin sheet screw |

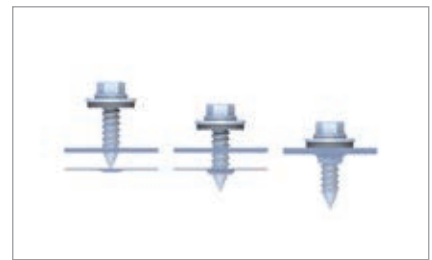

Chipless screwing for high holding forces



protection layer below insertion rails

Metal tile roof | clamping system

Clamping system with direct fixing and modules installed in landscape

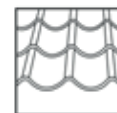

Pre-assembled components – fast mounting

- most cost effective mounting option on metal tile roof
- module clamping in the optimum clamping range
- reduced logistical effort on the roof
- quick and efficient mounting from above
- electrically conductive connection between the mounting system and the roof membrane

product variants

- short rail C24 for the yield-optimised installation
- short rail C47 for excellent module rear ventilation with extra space to the roof covering

Your benefits

- only a handful of components, entirely pre-assembled
- low material costs and easy handling
- high holding forces thanks to chipless direct fixing with building authority-approved thin sheet screws
- only one mounting tool necessary



Middle clamp in short rail C33



Short rail C33

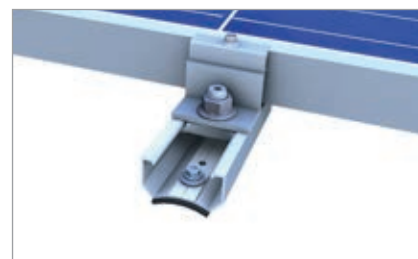

Slip guard on short rail for landscape

novotegra | clamping system

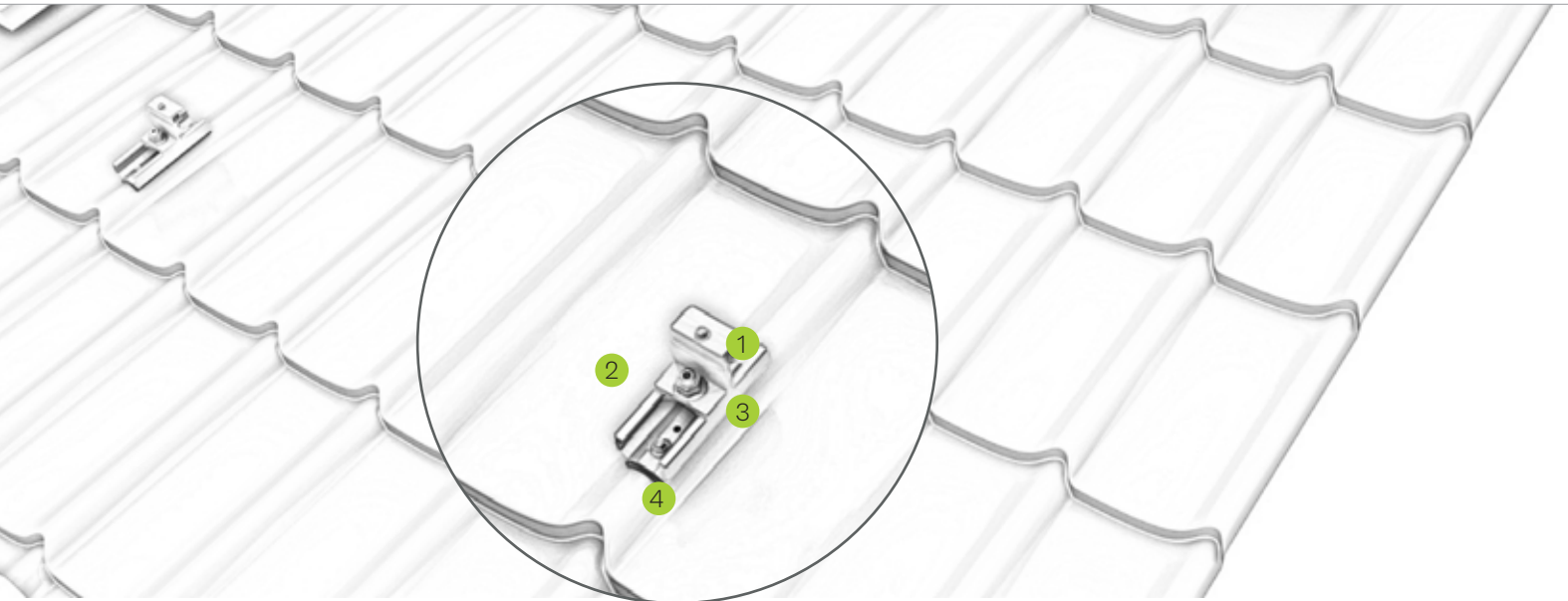

Pic Designation

- | | |
|---|--|
| 1 | Middle and end clamp <ul style="list-style-type: none"> ▪ for frame heights of 30-42 mm and 43-52 mm ▪ available in blank and black anodized |
| 2 | Short rail <ul style="list-style-type: none"> ▪ entirely pre-assembled with EPDM-sealing and perforations ▪ optimum fit on the high bead for common plates |
| 3 | Slip guard <ul style="list-style-type: none"> ▪ mounting aid for the lowest module row ▪ additional securing of modules |
| 4 | Mounting screw <ul style="list-style-type: none"> ▪ building authority-approved for chipless direct fixing ▪ high holding forces thanks to funnel formation |

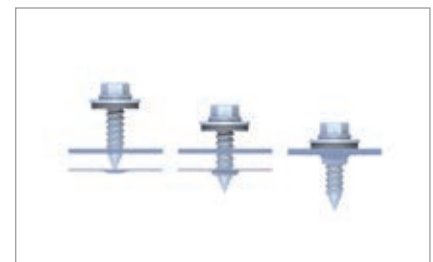

Chipless screwing for high holding forces

Metal tile roof | clamping system

Clamping system with direct fixing and modules installed in portrait

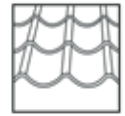

Vertical module installation – always the right solution

- module clamping in the optimum clamping range
- reduced logistical effort on the roof
- quick and efficient mounting from above
- electrically conductive connection between the mounting system and the roof membrane

product variants

- short rail C24 for the yield-optimised installation
- short rail C47 for excellent module rear ventilation with extra space to the roof covering

Your benefits

- only a handful of components, entirely pre-assembled
- low material costs and easy handling
- high holding forces thanks to chipless direct fixing with building authority-approved thin sheet screws
- only one mounting tool necessary

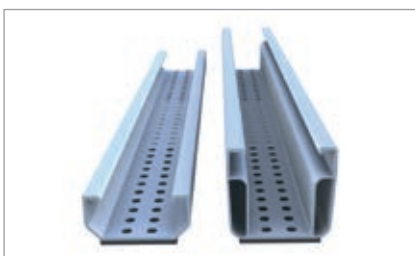

Versions of short rail 385 mm with EPDM seal



Hole pattern short rail for portrait



Middle clamp in short rail C47

novotegra | clamping system

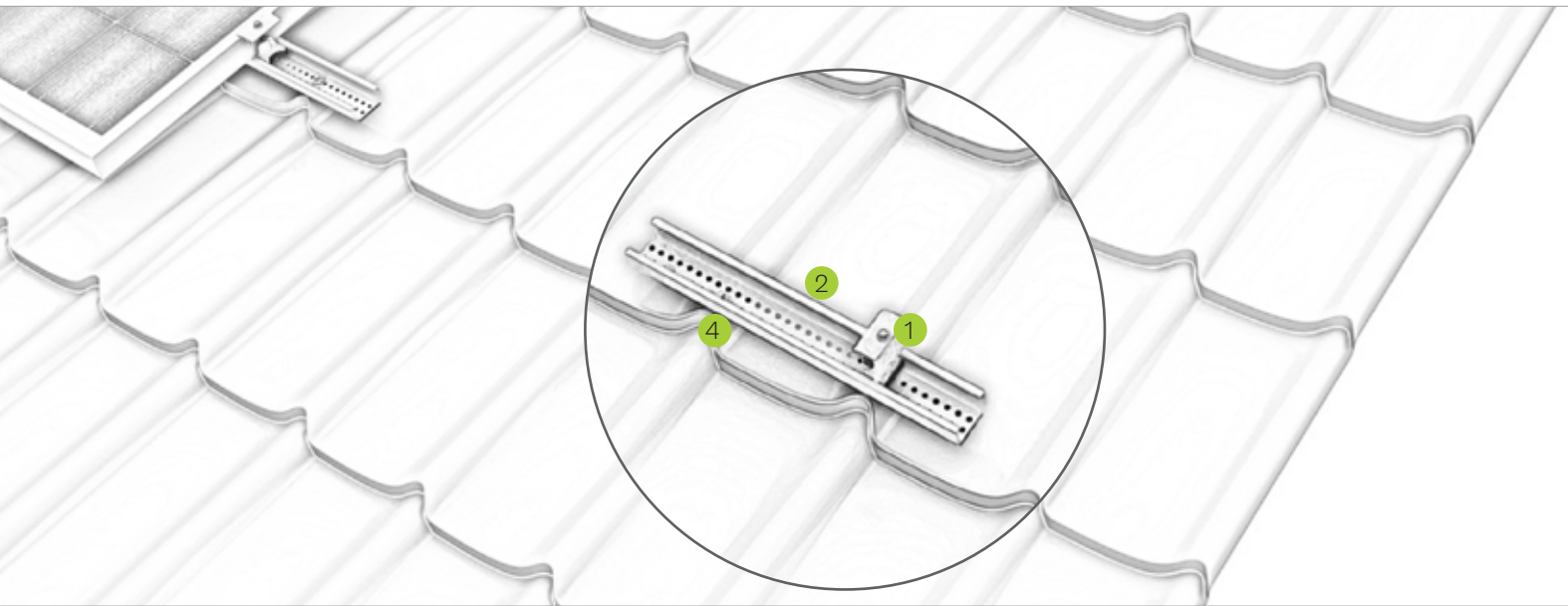

Pic Designation

- | | |
|---|--|
| 1 | Middle and end clamp <ul style="list-style-type: none"> ▪ for frame heights of 30-42 mm and 43-52 mm ▪ available in blank and black anodized |
| 2 | Short rail <ul style="list-style-type: none"> ▪ material-saving fixation on the raised bead ▪ entirely pre-assembled with EPDM-sealing and perforations |
| 3 | Slip guard <ul style="list-style-type: none"> ▪ for fixing modules with mounting holes 6-10 mm for mounting modules in portrait |
| 4 | Mounting screw <ul style="list-style-type: none"> ▪ building authority-approved for chipless direct fixing ▪ high holding forces thanks to funnel formation |

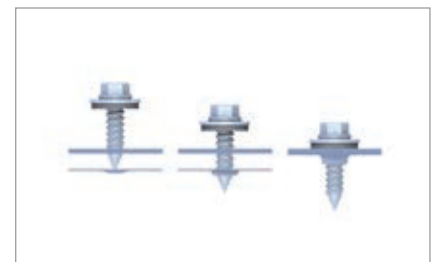

Chipless screwing for high holding forces



Slip guard for fixing modules

Bitumen roof | clamping system

Clamping system with direct fixing and modules installed in portrait or landscape

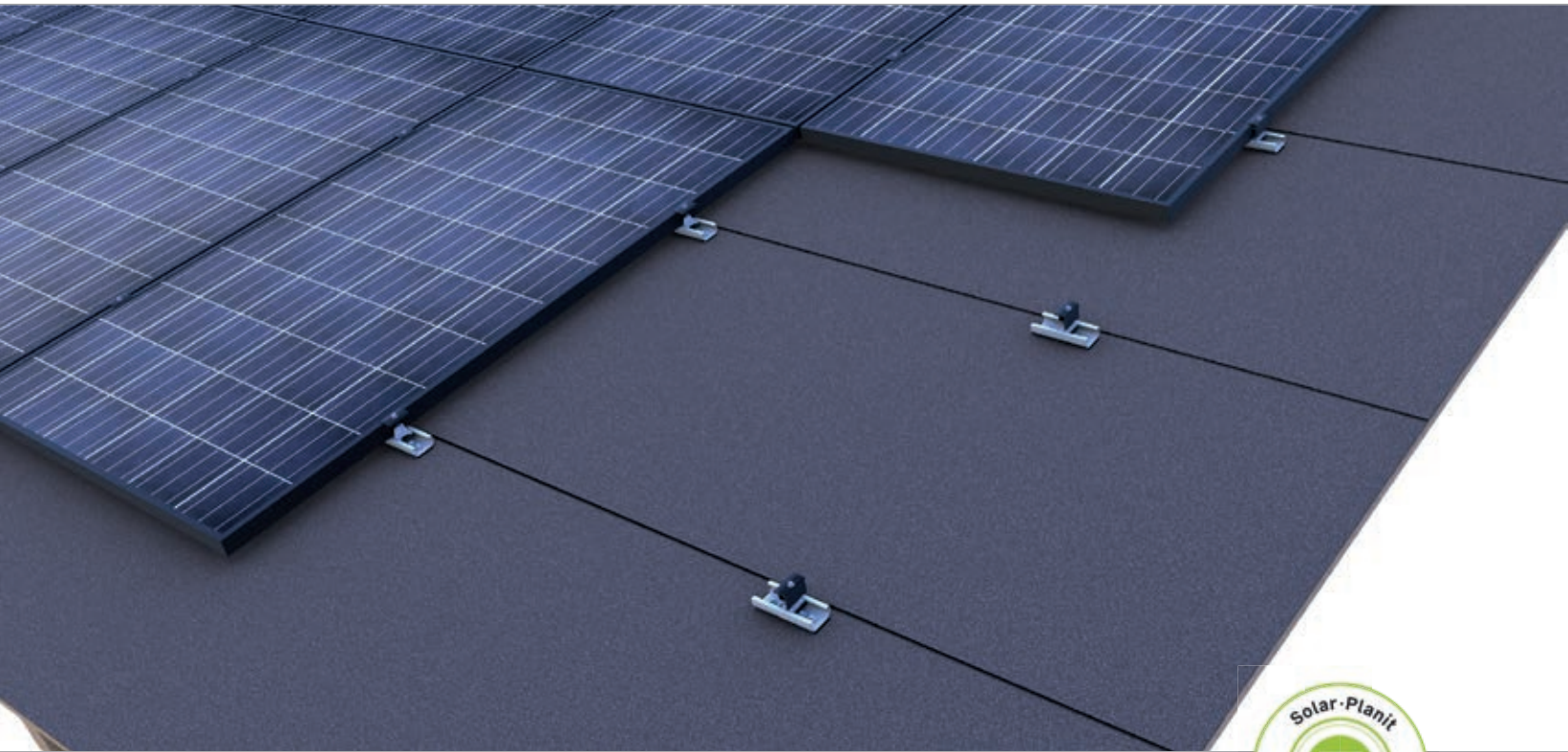

Mounting in landscape or in portrait – direct fixing on bitumen

- mounting modules in portrait or in landscape
- module clamping in the optimum clamping range
- reduced logistical effort
- quick and efficient mounting from above

produkt variants

- short rail C24 for the yield-optimised installation or the project business
- short rail C47 for excellent module rear ventilation with extra space to the roof covering

Your benefits

- only a handful of components, entirely preassembled
- low material costs and easy handling
- Direct fixing with building authority-approved mounting screws
- only one mounting tool necessary

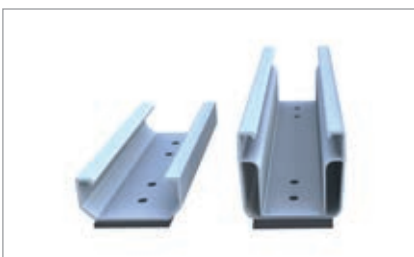

Short rails C24 and C47

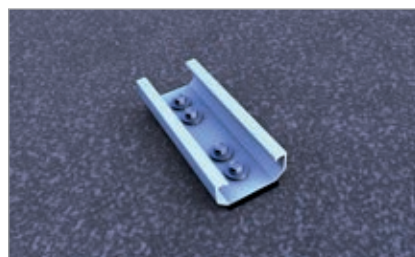

short rail C24 with four mounting screws for high wind loads



Middle clamp in short rail C47

novotegra | clamping system

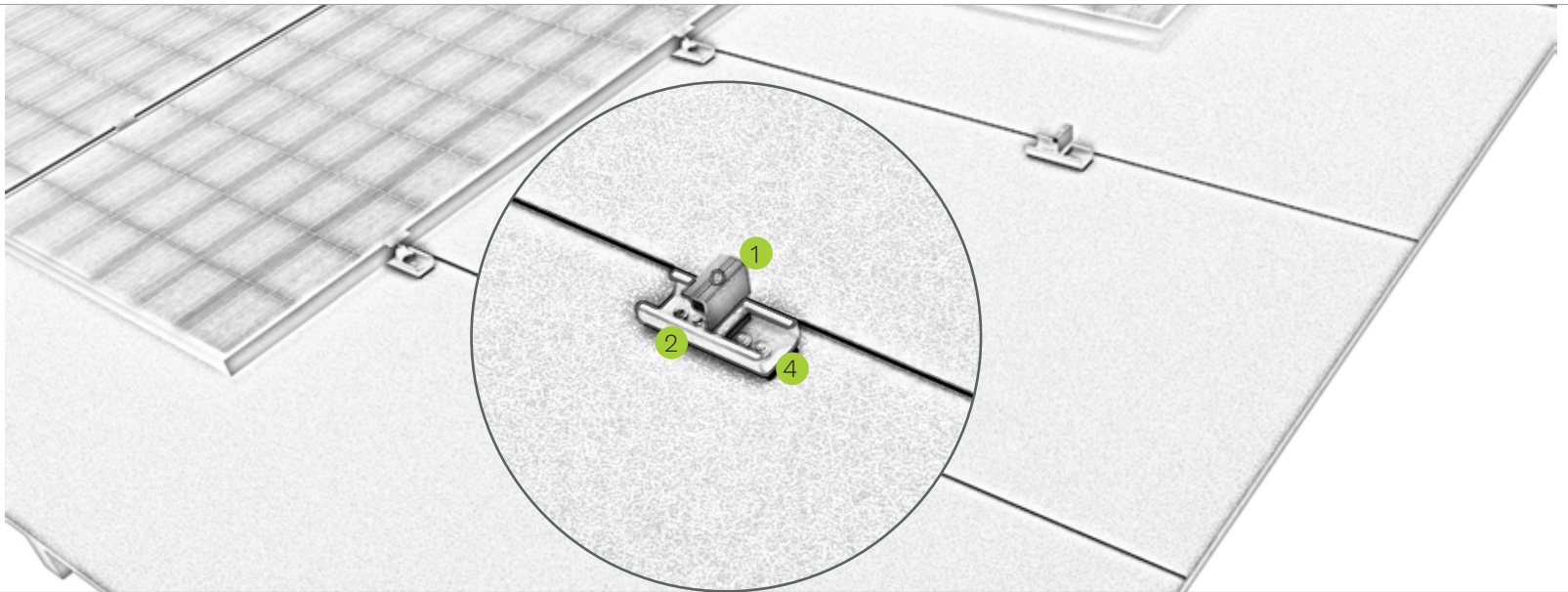

Pic Designation

- | | |
|---|---|
| ① | <p>Middle and end clamp</p> <ul style="list-style-type: none"> ▪ for frame heights of 30-42 mm and 43-52 mm ▪ available in blank and black anodized |
| ② | <p>Short rail</p> <ul style="list-style-type: none"> ▪ material-saving fixation ▪ entirely pre-assembled with EPDM-sealing and perforations |
| ③ | <p>Slip guard</p> <ul style="list-style-type: none"> ▪ for fixing modules mounted in landscape and portrait ▪ mounting aid for the lowest module row |
| ④ | <p>Mounting screw</p> <ul style="list-style-type: none"> ▪ building authority-approved ▪ individual calculation of the fasteners |



Slip guard for fixing modules in landscape

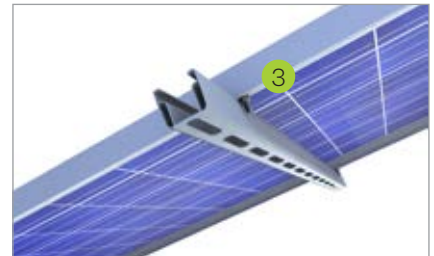

Slip guard for fixing modules in portrait

Mounting solutions for trapezoidal roofs



Roof-parallel applications with direct fixing



Clamping system: In portrait short rail



Clamping system: In landscape short rail

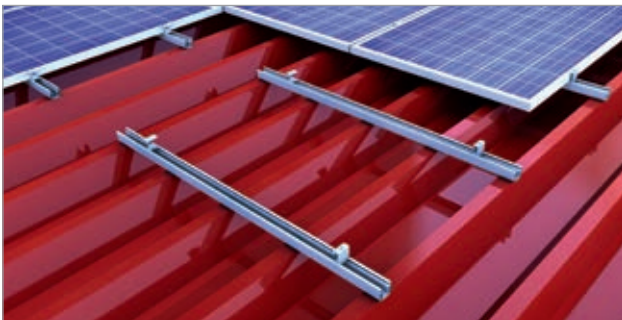

Clamping system: In portrait rail pieces

Your benefits

- clamping and insertion systems for mounting modules in portrait or in landscape
- only a handful of components, low installation workload and cost-effective
- quick mounting thanks to direct fixing with chipless screws



Insertion system: In portrait trapezoidal sheet bracket



Insertion system: In landscape short rail



Mounting solutions for trapezoidal roofs

Elevated applications with direct fixing



Insertion system: South-facing with triangle on bridge



Clamping system: South-facing

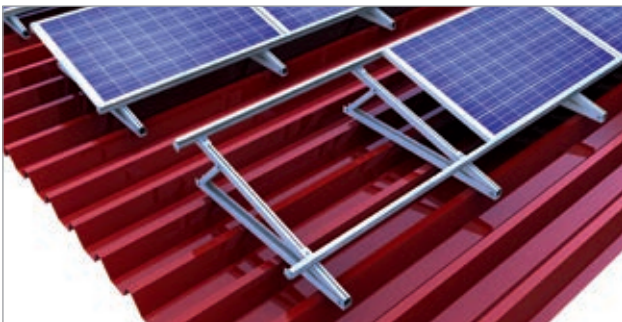

Insertion system: South-facing with triangle on east-west roof



Clamping system: South-facing on east-west roof



Clamping system: In portrait

Your benefits

- for elevation angles of 3 - 18° or 13 - 40°
- module elevation solutions for all roof orientations
- insertion system with elevation triangles for direct fixing



Corrugated and sandwich roof | clamping system

Single-rail clamping system with modules installed in landscape

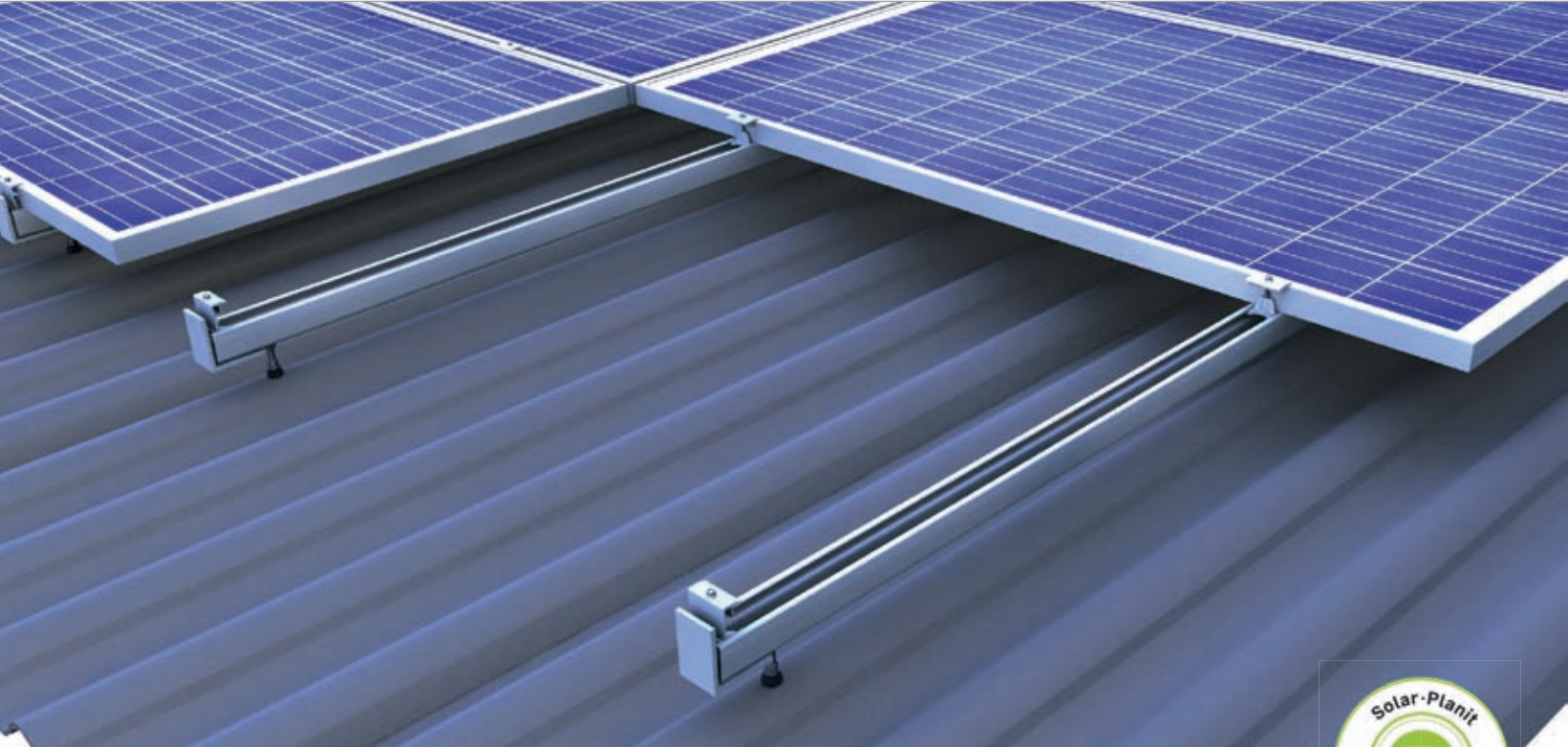
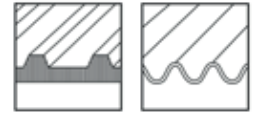

Simple mounting system technology

- components usable across different roof types
- module portrait installation possible with cross layer system
- only two clamps for all frame heights in blank and black anodized

product variants

- also suitable for sandwich and trapezoidal roofs
- stock screws for wooden and steel purlins
- stock screws for wood available in M10 and M12

Your benefits

- completely pre-assembled stock screws with centric load distribution
- big span lengths possible (C-rail 71-2 / C-rail 95-3)
- C-rail also acts as a cable channel
- solutions for timber and steel purlin



Centric load distribution in to the stock screw



C-rail for various spans



C-rail as cable channel

novotegra | clamping system

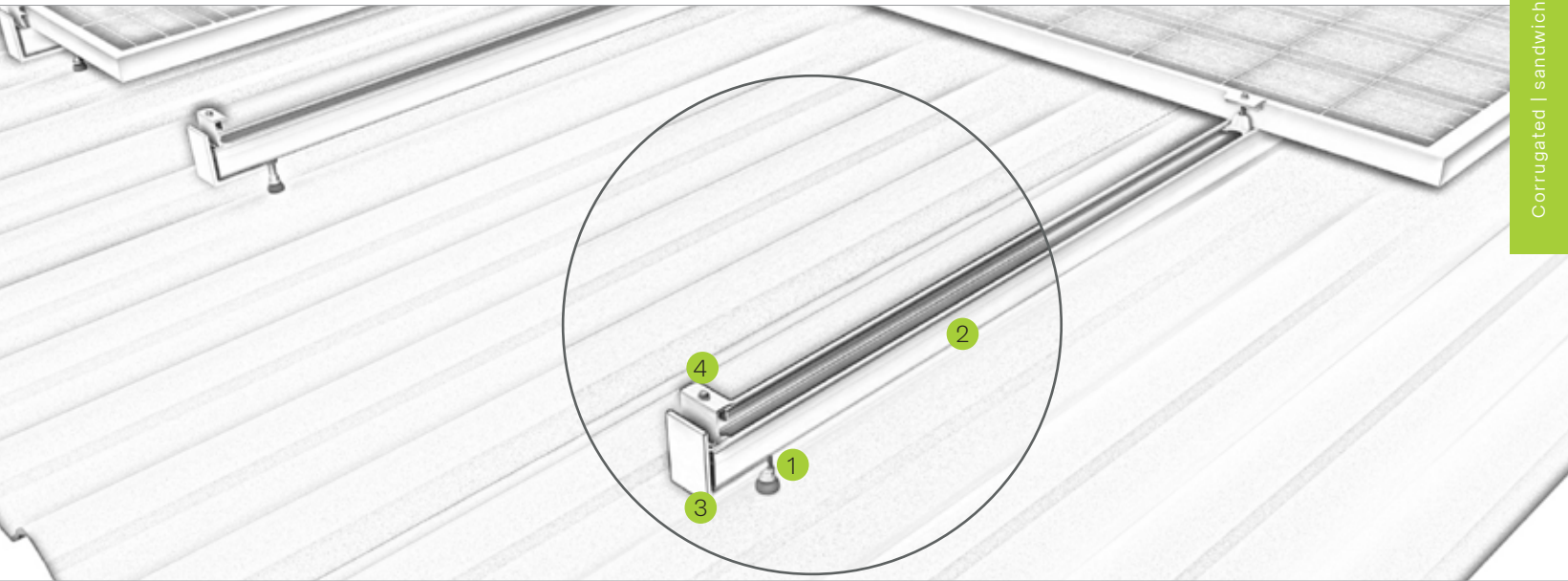

Pic Designation

- | | |
|---|---|
| ① | <p>Middle and end clamp</p> <ul style="list-style-type: none"> ▪ for frame heights of 30-42 mm and 43-52 mm ▪ installation-friendly thanks to click-in mechanism |
| ② | <p>C-rail</p> <ul style="list-style-type: none"> ▪ available in different strength and lengths ▪ can be stepped on throughout installation |
| ③ | <p>End cap</p> <ul style="list-style-type: none"> ▪ for optically tidy rail ends ▪ slip guard for fixing modules mounted in landscape |
| ④ | <p>Stock screw</p> <ul style="list-style-type: none"> ▪ high load capacity due to centric load distribution ▪ completely pre-assembled |



Stock screw entirely pre-assembled



Middle clamp in C-rail 47

Corrugated and sandwich roof | insertion system

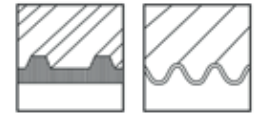

Insertion system with modules installed in portrait

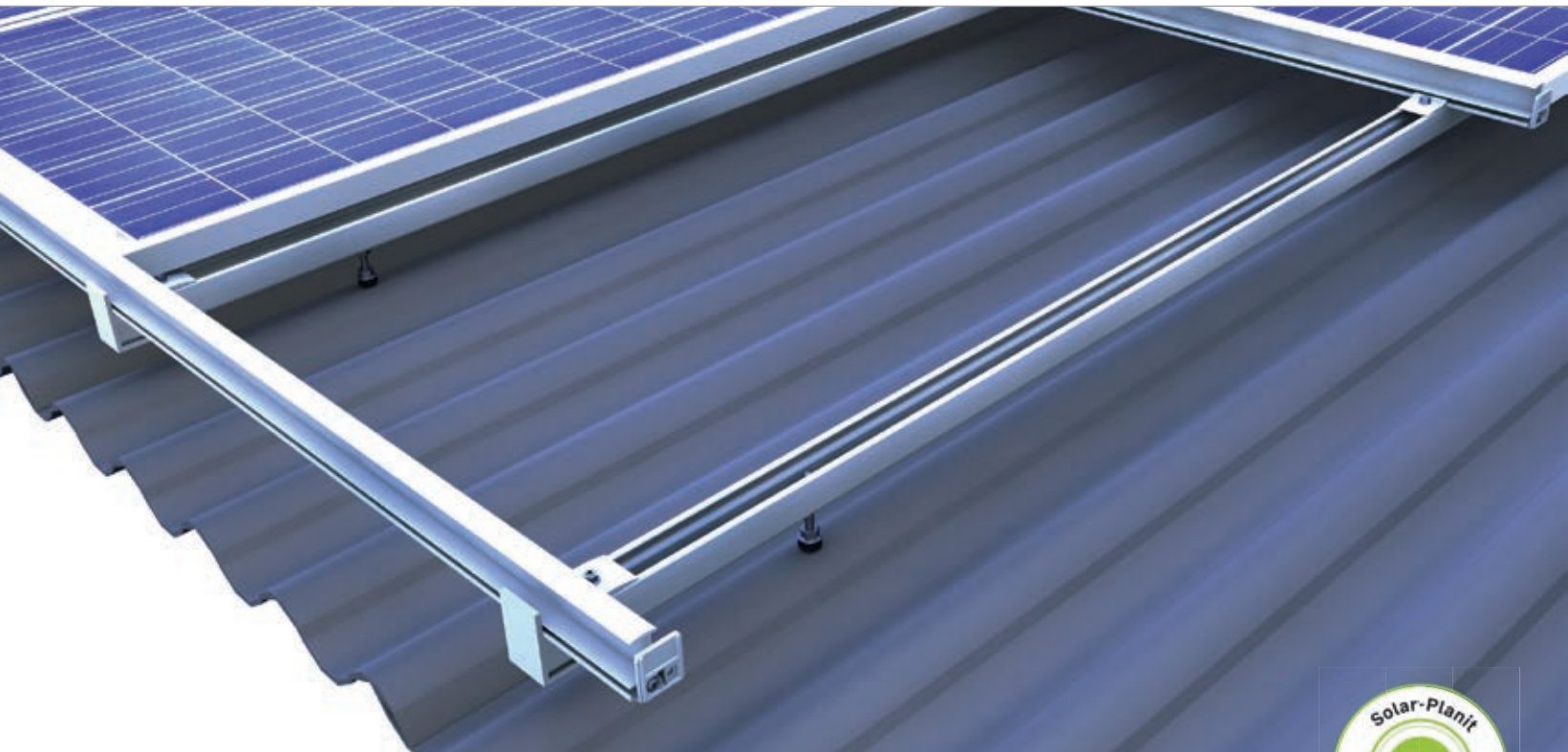

Easy, stable and flexible

- components usable across different roof types
- C-rail also acts as a cable channel
- mounting modules in portrait or in landscape
- insertion rail in blank and black anodized – color matching the module

product variants

- also suitable for sandwich and trapezoidal metal roofs
- stock screws for wooden and steel purlins
- stock screws for wood available in M10 and M12

Your benefits

- high-end installation aesthetics and time-efficient mounting thanks to insertion technology
- completely pre-assembled stock screws with centric load distribution
- big span lengths possible (C-rail 71-2 / C-rail 95-3)
- tension-free and floating module mounting



C-rail for various spans



C-rail as cable channel

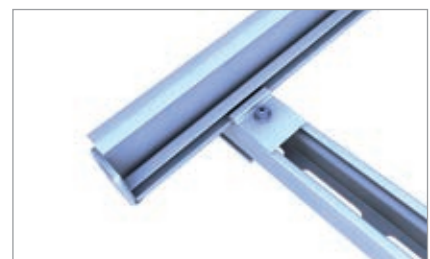

Fixation insertion rail to C-rail

novotegra | insertion system

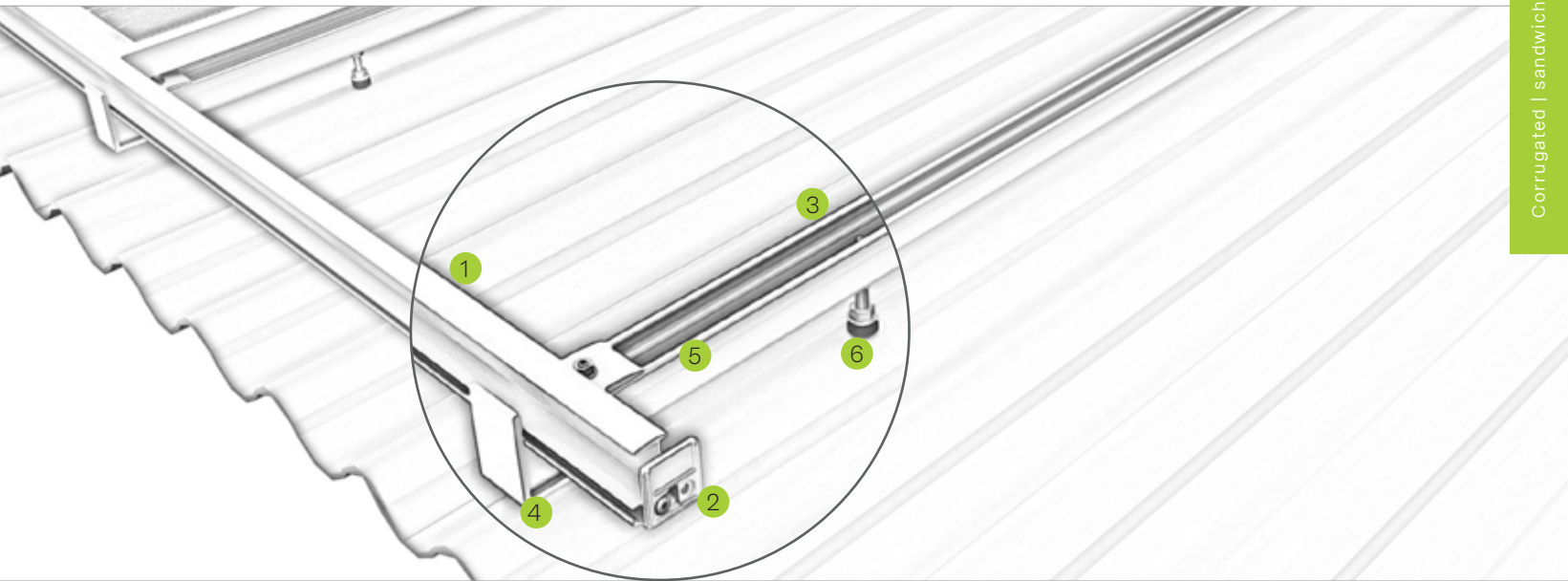

Pic Designation

- | | |
|---|--|
| 1 | Insertion rail <ul style="list-style-type: none"> ▪ insertion rails in blank/black anodized for frame heights ▪ tension-free and floating module mounting |
| 2 | Edge stop <ul style="list-style-type: none"> ▪ color-coordinated with the insertion rail ▪ prevents modules from slipping out |
| 3 | C-rail <ul style="list-style-type: none"> ▪ available in different strength and lengths ▪ can be stepped on throughout installation |
| 4 | End cap <ul style="list-style-type: none"> ▪ for optically tidy rail ends ▪ color-coordinated with the rail |
| 5 | Cross-rail connector <ul style="list-style-type: none"> ▪ safe connection due to force and form closure ▪ completely pre-assembled |
| 6 | Stock screw <ul style="list-style-type: none"> ▪ high load capacity due to centric load distribution ▪ completely pre-assembled |



Fixation insertion rail to C-rail



Rail connector insertion rail

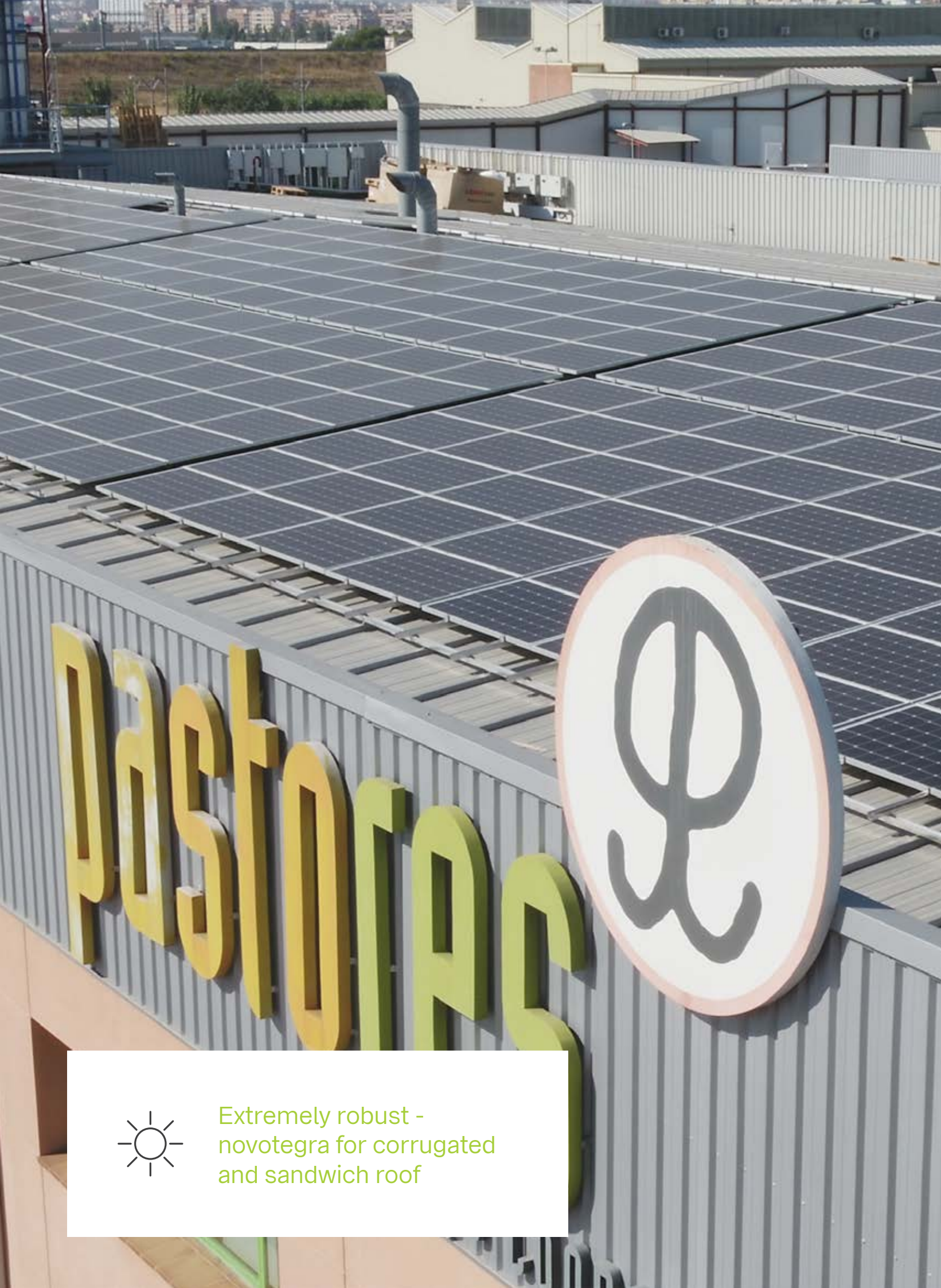

Extremely robust -
novotegra for corrugated
and sandwich roof

Mounting solutions for corrugated and sandwich roof

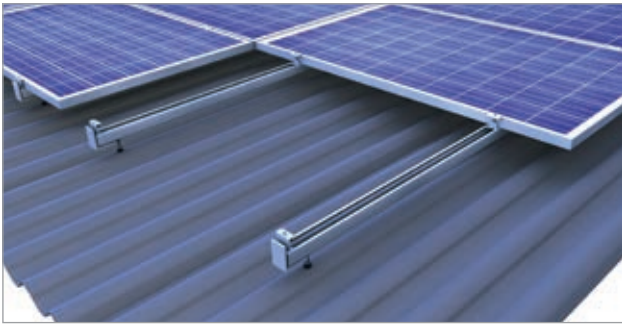

Clamping system: Single-rail in landscape

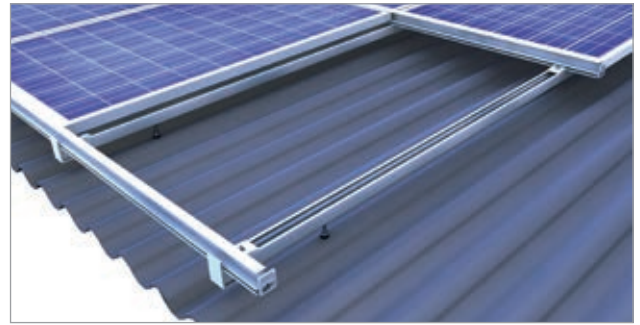

Insertion system: In portrait

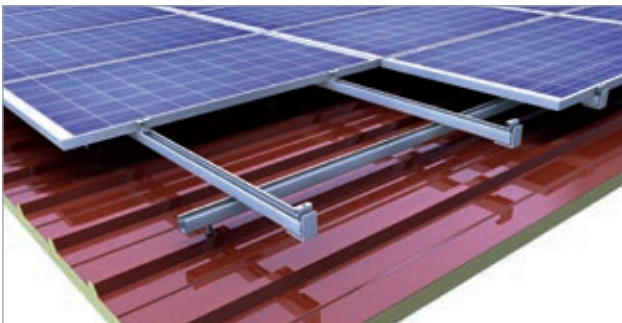

Clamping system: Cross-rail in portrait

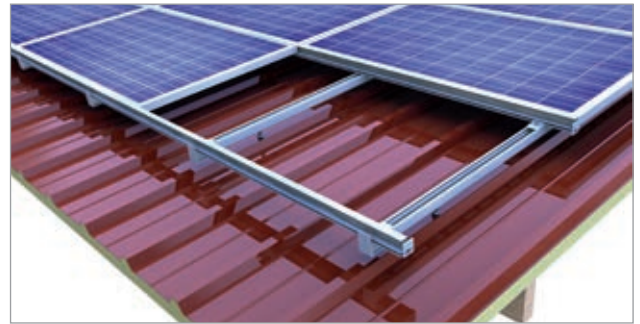

Insertion system: In landscape

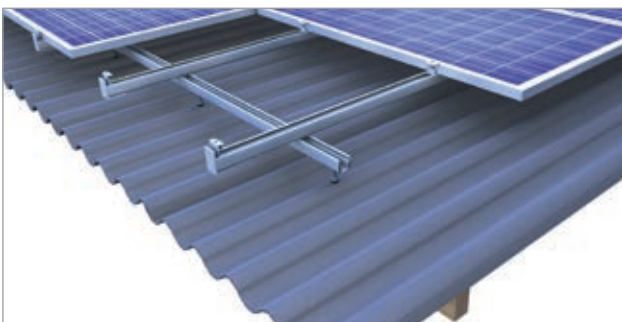

Clamping system: Cross-rail in landscape



Insertion system: In landscape



Your benefits

- clamping and insertion systems for mounting modules in portrait and in landscape
- centric load distribution to the stock screw, making the system suitable for very heavy loads
- rail with an integrated cable channel and room for plugs
- quick mounting from above with easily graspable components

Seamed metal roof | clamping system top-fix

Single-rail clamping system with modules installed in portrait

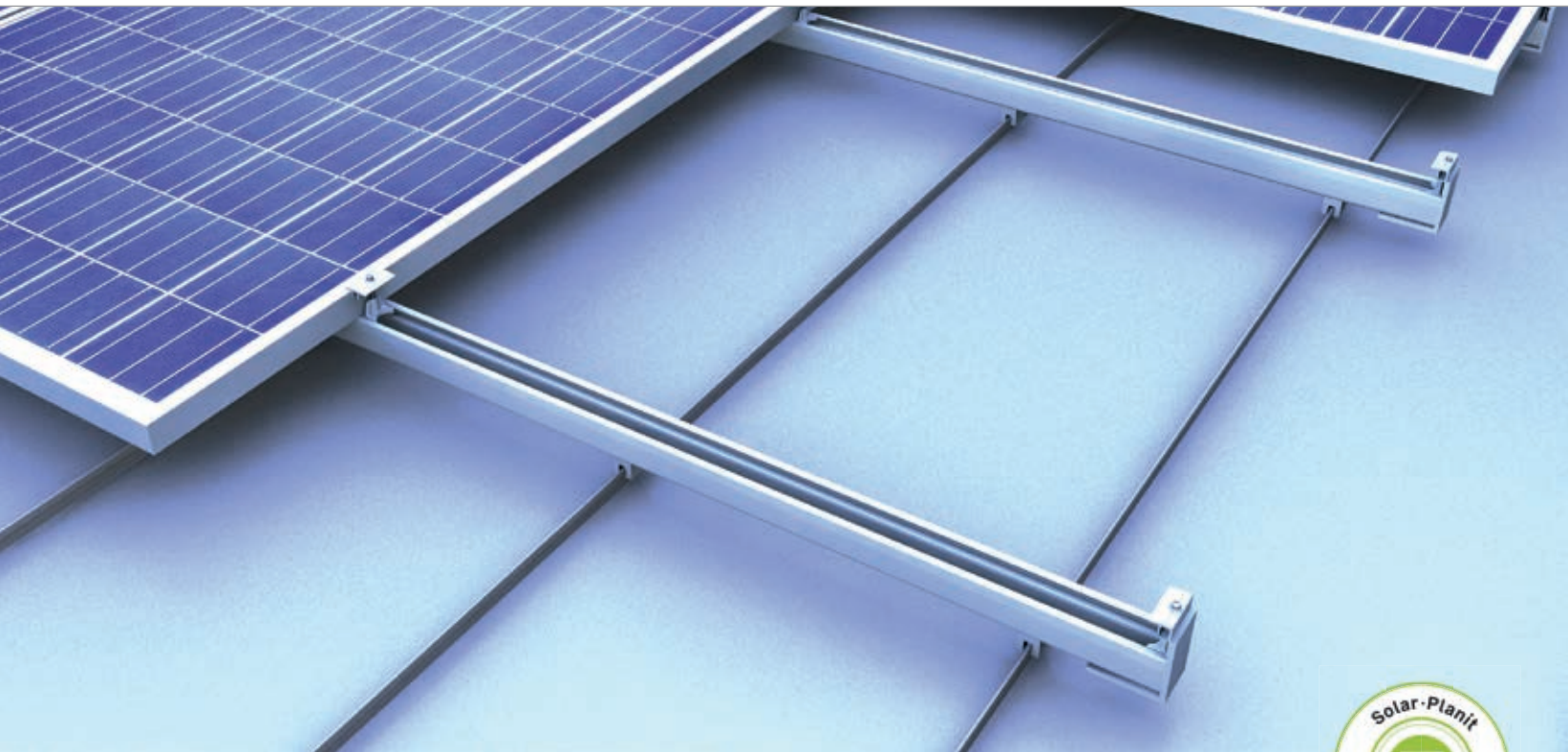

Perfect for seamed metal roofs

- excellent module rear ventilation
- installation-friendly clamps with a click-in mechanism
- components usable across different roof types
- quick and efficient mounting from above with easily graspable components

product variants

- also suitable for standing seam roofs made of copper
- seam clamps for standing seam and round seam
- rails and clamps available in blank and black anodized

Your benefits

- only a handful of components – entirely pre-assembled
- centric load distribution
- C-rail also acts as a cable channel
- quick mounting from above with easily graspable components



Rounded seam clamp



Centric load distribution in to the seam clamp



C-rail as cable channel

novotegra | clamping system

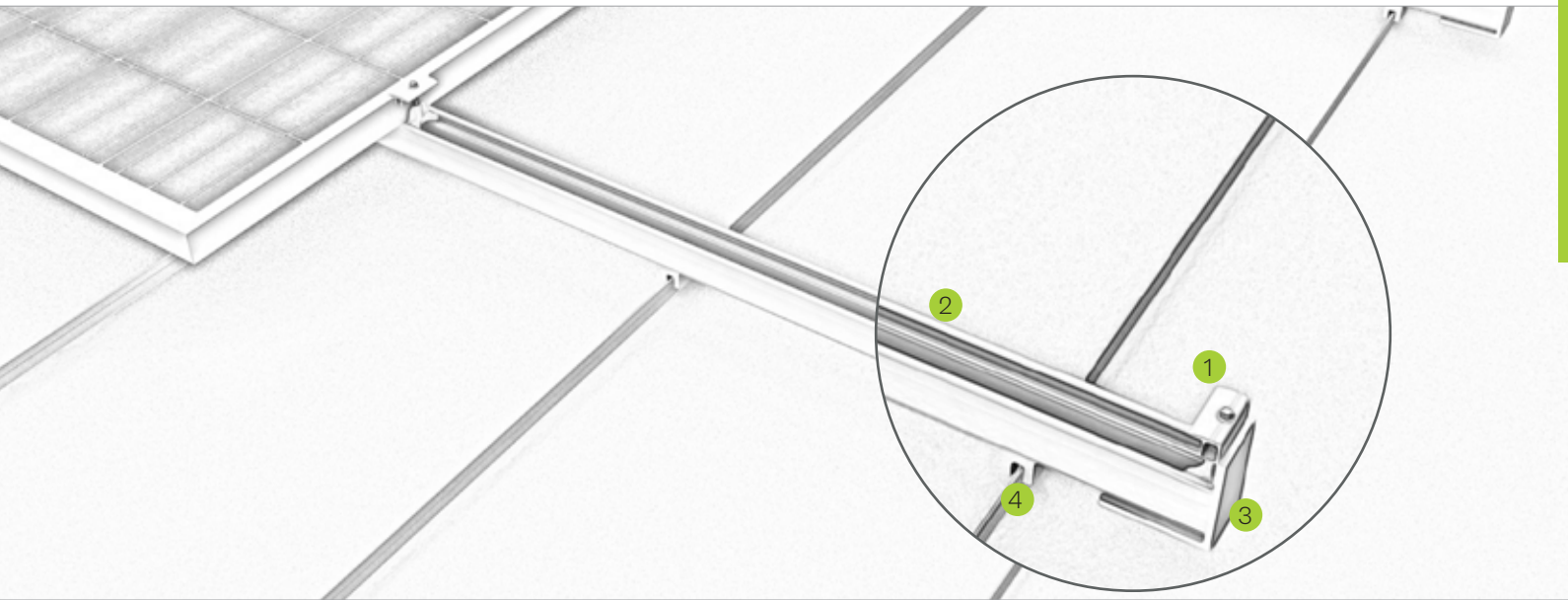

Pic Designation

- | | |
|---|--|
| 1 | Middle and end clamp <ul style="list-style-type: none"> ▪ in blank / black for all frame heights ▪ installation-friendly thanks to click-in mechanism |
| 2 | C-rail <ul style="list-style-type: none"> ▪ available in different strength and lengths ▪ can be stepped on throughout installation |
| 3 | End cap <ul style="list-style-type: none"> ▪ for optically tidy rail ends ▪ UV and weather resistant |
| 4 | Seam clamp <ul style="list-style-type: none"> ▪ centric load distribution ▪ completely pre-assembled |
| 5 | A2SS saddle <ul style="list-style-type: none"> ▪ for copper roof ▪ prevents oxidation of the component |



C-rail connector extern

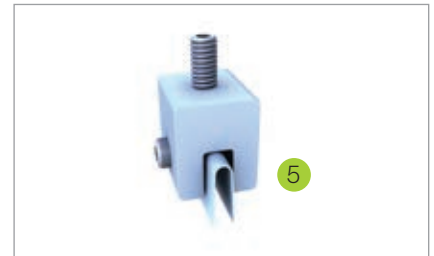

Clamp with VA saddle for copper standing seam roofs

Seamed metal roof | insertion system top-fix

Single-rail insertion system with modules installed in landscape

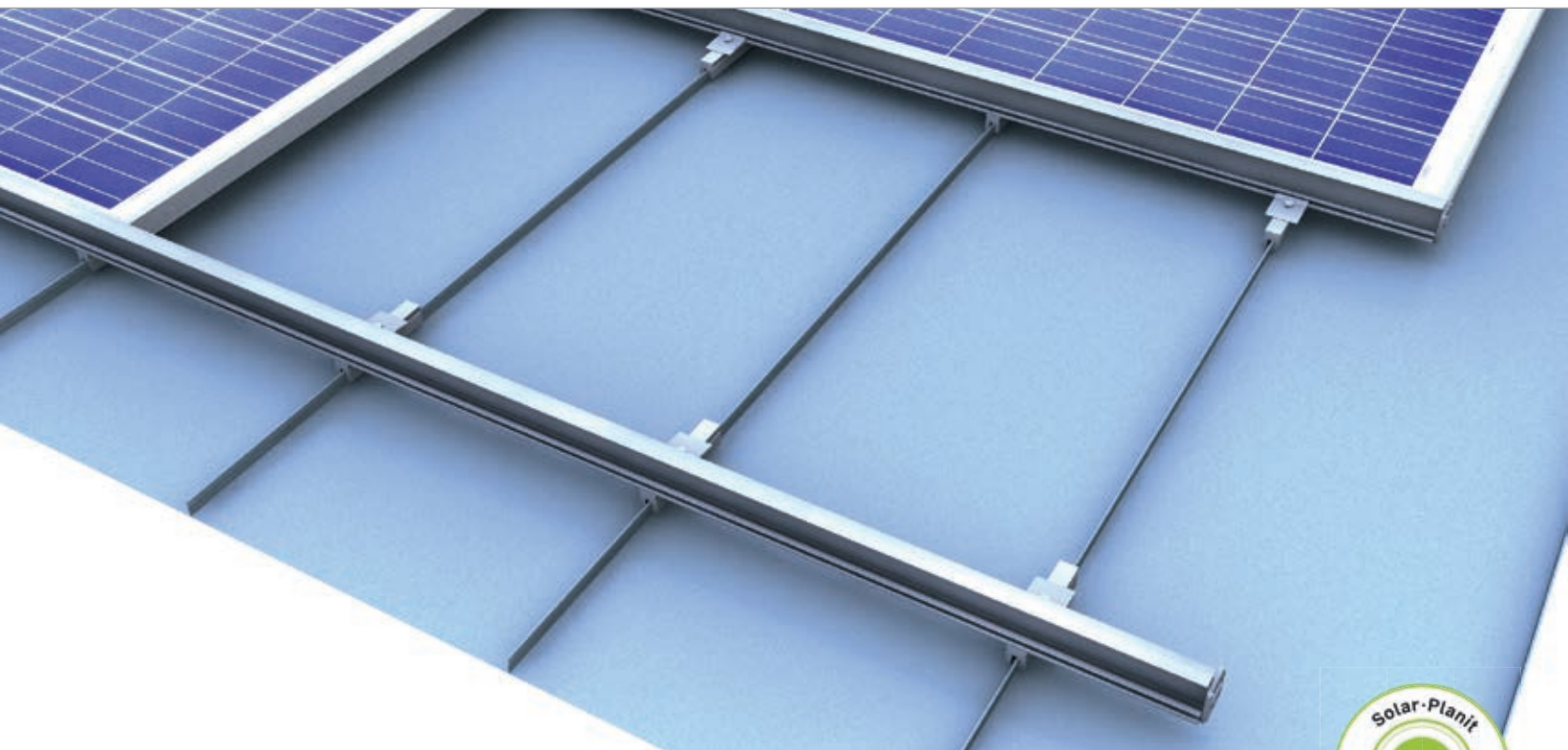
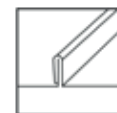

Perfect aesthetic and high efficiency

- clamping technology with clamping points on the seam flanging
- mounting modules in portrait or in landscape
- quick and efficient mounting from above
- Clamp for insertion system on standing seam roof completely pre-assembled with cross rail connector

product variants

- also suitable for standing seam roofs made of copper
- insertion rail in blank and black anodized – color matching the module

Your benefits

- high-end installation aesthetics and time-efficient mounting thanks to insertion technology
- only a handful of components – quick assembly
- cost-optimised single-rail system
- tension-free and floating module mounting

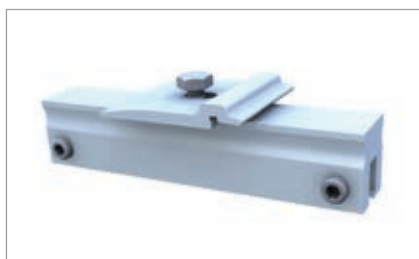

Clamp for insertion system on standing seam

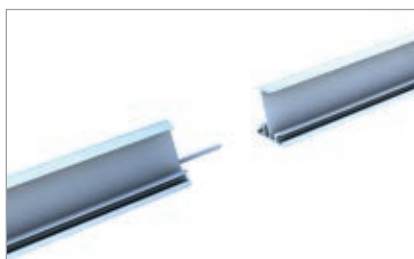

Rail connector insertion rail

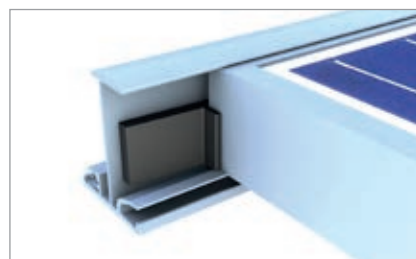

Module security at low roof inclination

novotegra | insertion system

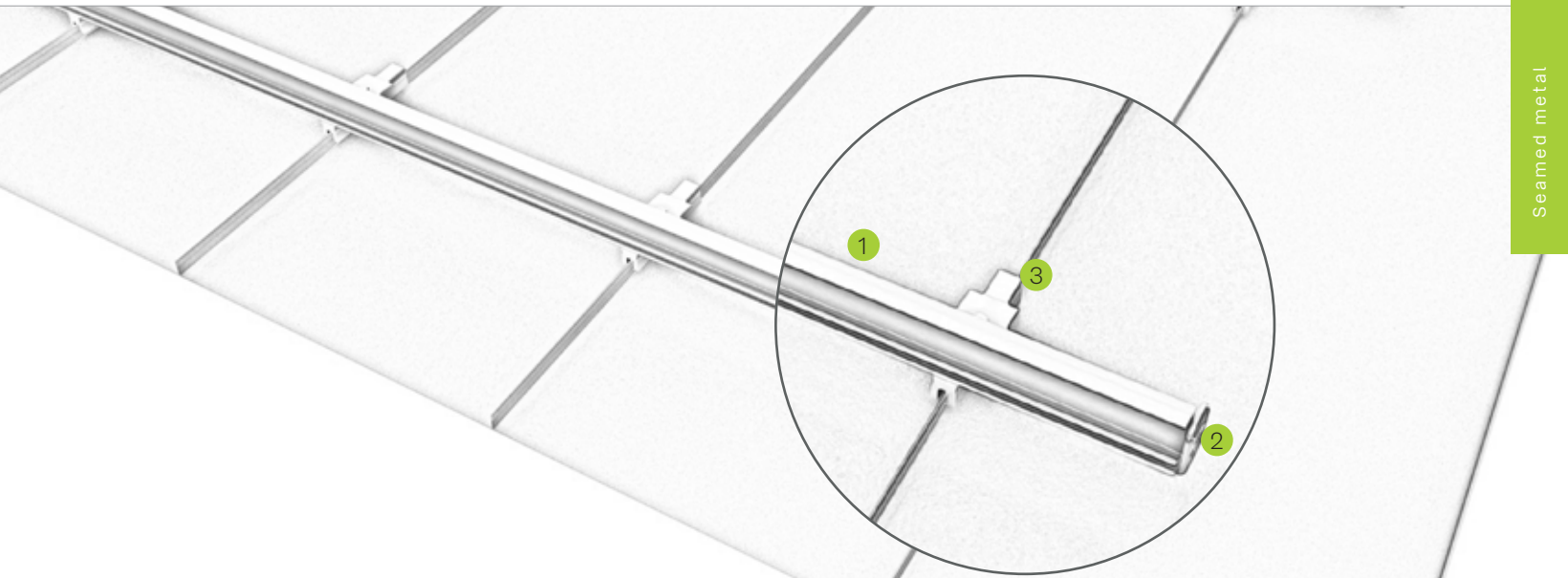

Pic Designation

- | | |
|---|--|
| ① | Insertion rail <ul style="list-style-type: none"> ▪ insertion rails in blank/black anodized for frame heights ▪ tension-free and floating module mounting |
| ② | Edge stop <ul style="list-style-type: none"> ▪ color-coordinated with the insertion rail ▪ prevents modules from slipping out |
| ③ | Seam clamp <ul style="list-style-type: none"> ▪ completely pre-assembled with cross rail connector ▪ easy connection to the insertion rail |
| ④ | VA saddle <ul style="list-style-type: none"> ▪ for copper roofs ▪ prevents oxidation of the component |



Fixation insertion rail to standing seam clamp



Standing seam clamp set IR for copper



Low installation workload –
novotegra for seamed metal
roofs



Mounting solutions for seamed metal roof

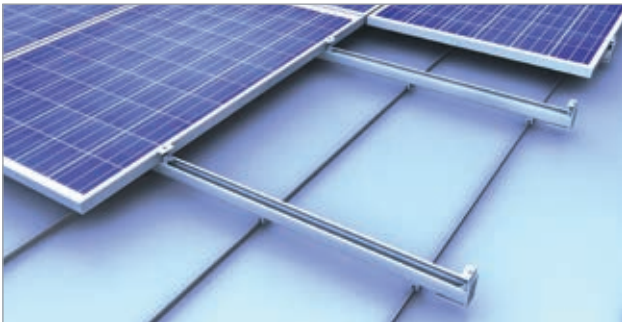

Clamping system: In portrait on standing seam



Clamping system: In portrait on round seam

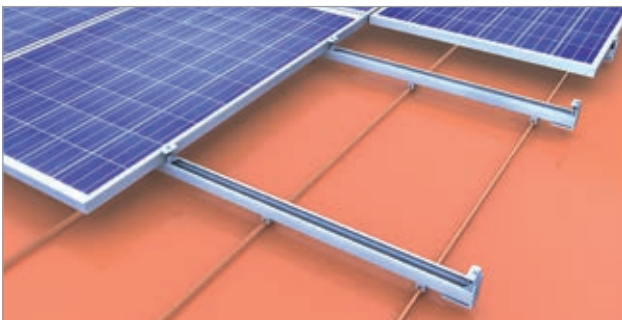

Clamping system: In portrait on standing seam copper roof

Your benefits

- clamping system for mounting modules in portrait, insertion systems for mounting modules in portrait and in landscape
- centric load distribution to the seam clamp
- rail with an integrated cable channel and room for plugs
- quick mounting from above with easily graspable components



Insertion system: In portrait on standing seam

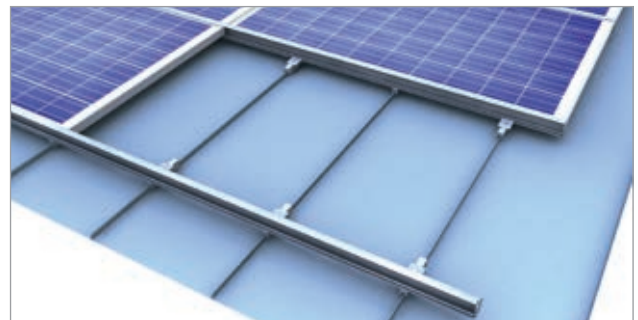

Insertion system: In landscape on standing seam



2

Single items
pitched roof

Roof attachment

Roof hook tile roof and beavertail

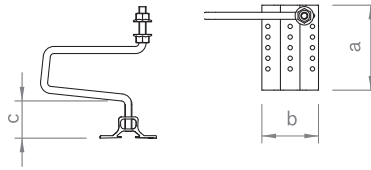

Roof hooks for mounting C-rails as vertical and horizontal rails, optimised for narrow rafters, rail-roof hook connection height-adjustable up to 30 mm, roof hook-base profile connection height-adjustable for 18 – 24 mm, 24 – 30 mm or 31 – 40 mm batten, for tile overlap up to approx. 80 mm.

Item no.	Designation	a in mm	b in mm	c in mm	Material
03-001109	Flex roof hook set 18 M10	120	80	23–47	Alu / A2SS
03-001149	Flex roof hook set 30 M10	120	80	40–52	Alu / A2SS
03-001151	Flex roof hook set 40 M10	120	80	50–62	Alu / A2SS

Double roof hook tile roof and beavertail

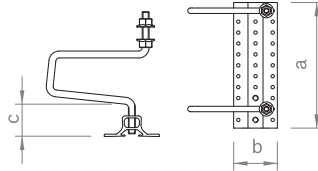

Roof hooks for mounting C-rails as horizontal rails, optimised for narrow rafters and heavy loads, rail-roof hook connection height-adjustable up to 30 mm, roof hook-base profile connection height-adjustable for 24 – 30 mm or 31 – 40 mm batten, for tile overlap up to approx. 80 mm.

Item no.	Designation	a in mm	b in mm	c in mm	Material
03-001150	Flex double roof hook set 30 M10	230	80	40–52	Alu / A2SS
03-001152	Flex double roof hook set 40 M10	230	80	50–62	Alu / A2SS

Roof hook tile roof

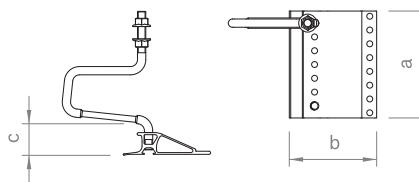

Roof hooks for mounting C-rails as vertical and horizontal rails, rail-roof hook connection height-adjustable up to 35 mm, roof hook-base profile connection height-adjustable for 24 – 30 mm or 31 – 40 mm batten, for tile overlap up to approx. 80 mm. Alternative packing units see p. 86.

Item no.	Designation	a in mm	b in mm	c in mm	Material
03-000254	Roof hook set ZD 30 M12	155	126	43–52	Alu / A2SS
03-000256	Roof hook set ZD 40 M12	155	126	57–63	Alu / A2SS

Roof attachment

Double roof hook tile roof

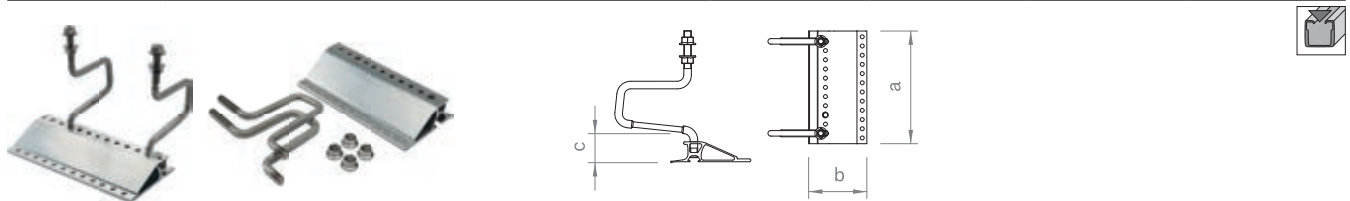

Roof hooks for mounting C-rails as horizontal rails, optimised for heavy loads, rail-roof hook connection height-adjustable up to 35^{mm}, roof hook-base profile connection height-adjustable for 24 – 30 mm or 31 – 40 mm batten, for tile overlap up to approx. 80 mm. Alternative packing units see p. 86.

Item no.	Designation	a in mm	b in mm	c in mm	Material
03-000255	Double roof hook set ZD 30 M12	245	125	43–52	Alu / A2SS
03-000257	Double roof hook set ZD 40 M12	245	125	57–63	Alu / A2SS

Roof hook beavertail

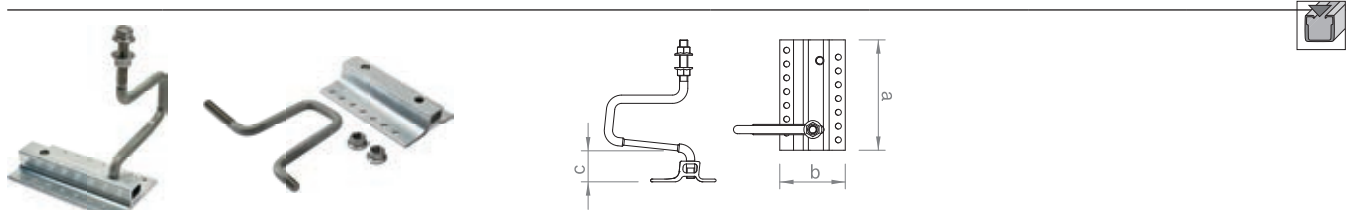

Roof hooks for mounting C-rails as vertical and horizontal rails on roofs with beavertail tiles, rail-roof hook connection height-adjustable up to 35 mm, roof hook-base profile connection height-adjustable for 24 – 30 mm batten, for beavertail double tile formation. Alternative packing units see p. 86.

Item no.	Designation	a in mm	b in mm	c in mm	Material
03-000258	Roof hook set BS 30 M12	160	95	42–48	Alu / A2SS

Double roof hook beavertail

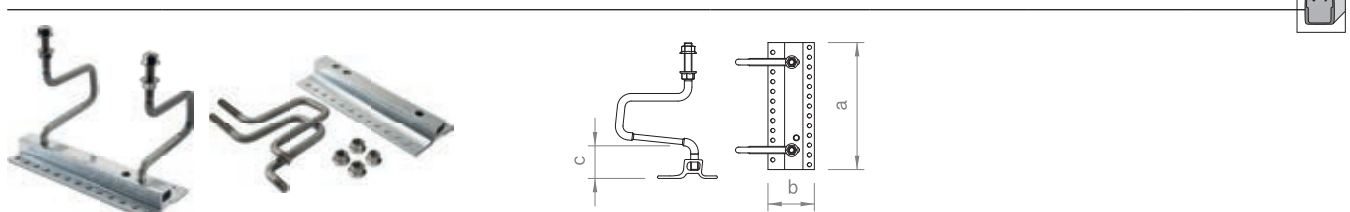

Roof hooks for mounting C-rails as horizontal rails on roofs with beavertail tiles, optimised for heavy loads, rail-roof hook connection height-adjustable up to 35 mm, roof hook-base profile connection height-adjustable for 24 – 30 mm batten, for beavertail double tile formation.

Item no.	Designation	a in mm	b in mm	c in mm	Material
03-000267	Double roof hook set BS 30 M12	260	95	42–48	Alu / A2SS

Roof attachment

Roof hook tile roof

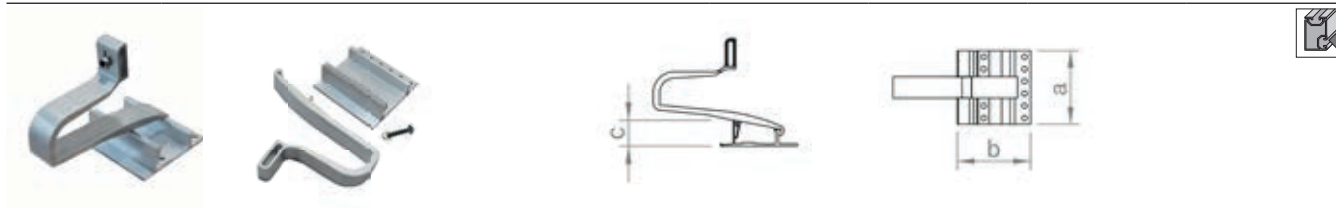

Roof hooks for mounting C-N-rails and N-rails as vertical and horizontal rails, rail-roof hook connection height-adjustable in slot with fluting up to approx. 20 mm, for tile overlap up to approx. 110 mm, including screws M8 for rail connection.

Item no.	Designation	a in mm	b in mm	c in mm	Material
03-001350	Roof hook set ZD 30 N35 vertical	120	119	45	Alu / A2SS
03-001351	Roof hook set ZD 30 N35 horizontal	120	119	45	Alu / A2SS

Roof hook tile roof

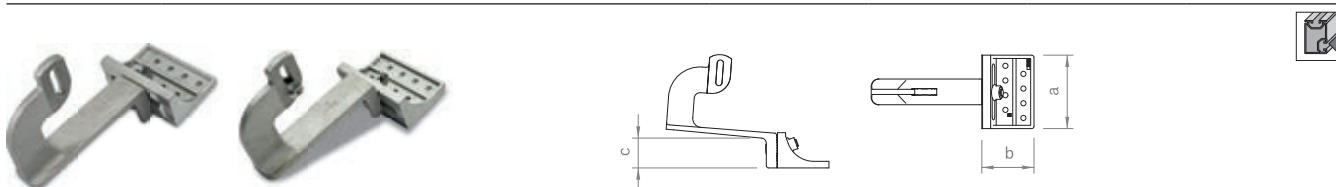

Roof hooks for mounting N-rails as vertical rails, rail-roof hook connection height-adjustable in slot 8.5 × 35 mm up to 26 mm, brackets on both sides 32.5 mm, in height 15 mm in slot adjustable, tile overlap up to approx. 100 mm for 30 mm roof battens, optionally pre-assembled with slot bolt M8.

Item no.	Designation	a in mm	b in mm	c in mm	Material
03-000756	Roof hook adjustable 633 vertical	100	70	41–56	Alu cast / A2SS
03-000949	Roof hook set adjustable 633 vertical M8	100	70	41–56	Alu cast / A2SS

Roof hook tile roof

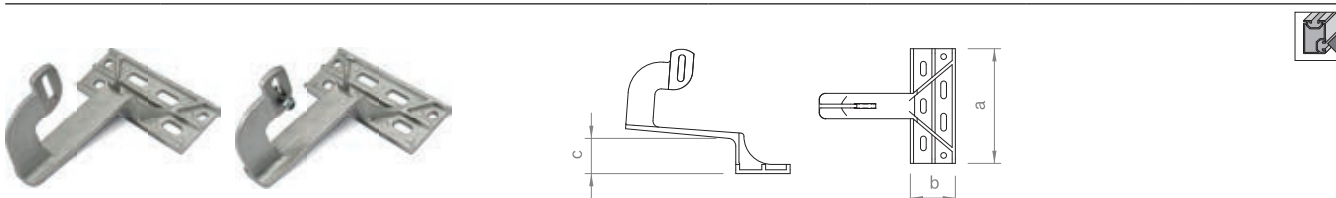

Roof hooks for mounting N-rails as vertical rails, rail-roof hook connection height-adjustable in slot 8.5 × 35 mm with fluting up to 26 mm, for tile overlap up to approx. 100 mm and 30 mm roof battens, optionally pre-assembled with slot bolt M8.

Item no.	Designation	a in mm	b in mm	c in mm	Material
03-000731	Roof hook ZD 533 vertical	181	71	46	Alu cast
03-000612	Roof hook set ZD 533 vertical M8	181	71	46	Alu cast / A2SS

Roof hook tile roof

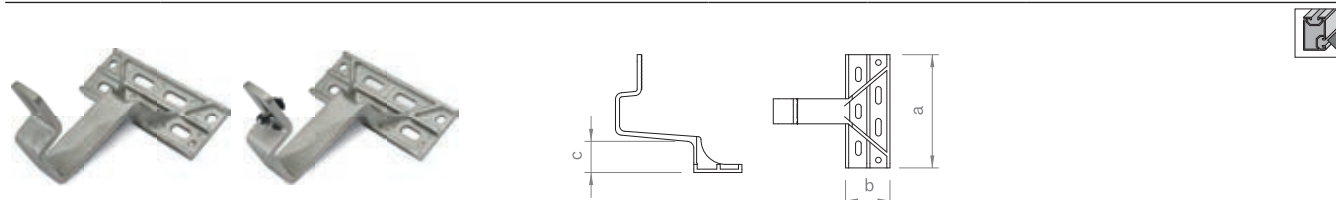

Roof hooks for mounting N-rails as horizontal rails, rail-roof hook connection height-adjustable in slot 8.5 × 35 mm with fluting up to 26 mm, for tile overlap up to approx. 100 mm and 30 mm roof battens, optionally pre-assembled with slot bolt M8.

Item no.	Designation	a in mm	b in mm	c in mm	Material
03-000611	Roof hook ZD 544 horizontal	181	71	46	Alu cast
03-000613	Roof hook set ZD 544 horizontal M8	181	71	46	Alu cast / A2SS

Roof attachment

Roof hook beavertail

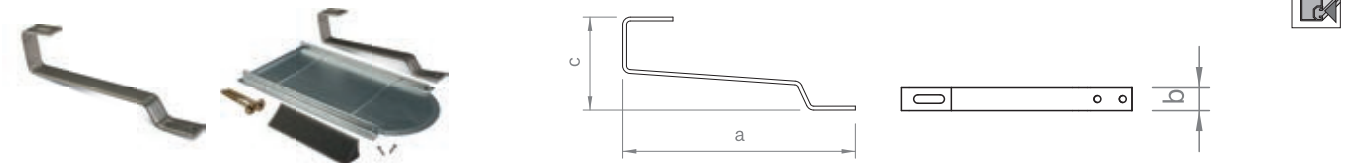

Roof hooks for mounting C-N-/N-rails as vertical and horizontal rails on roofs with beavertail tiles, rail-roof hook connection with L-adapter in slot 11 × 41 mm, for 24 mm roof battens. As a set with underlay plate, screws and sealing wedge, for beavertail double tile formation.

Item no.	Designation	a in mm	b in mm	c in mm	Material
03-000410	Roof hook BS C-shape A2SS	300	30	120	A2SS
03-000411	Roof hook set BS C-shape A2SS with sheet	300	30	120	A2SS
03-000412	Metal sheet zinc-plated, for plain tile	300	30	120	A2SS

Roof hook slate

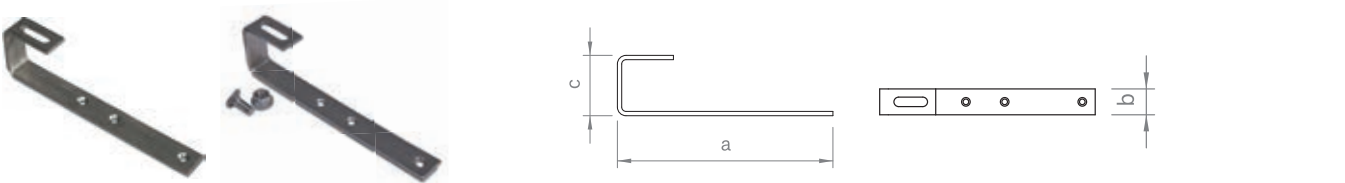

Roof hooks for mounting C-N-/N-rails or C-rails as vertical and horizontal rails on roofs with slate or shingle roofing, rail-roof hook connection with L-adapter in slot 11 × 41 mm or as a set with round-head screw M10, with flat foot area.

Item no.	Designation	a in mm	b in mm	c in mm	Material
03-000694	Roof hook S C-shape A2SS	250	30	70	A2SS
03-001219	Roof hook set S C-shape A2SS M10	250	30	70	A2SS

Shim for roof hook ZD 30 N35



Shim for side-fix roof hooks for height compensation between the roof hook and the roof batten.

Item no.	Designation	a in mm	b in mm	c in mm	Material
03-001338	Shim for roof hook ZD 30 N35, 2mm				PP
03-001339	Shim for roof hook ZD 30 N35, 5mm				PP

Shim for roof hook ZD 544 und 533

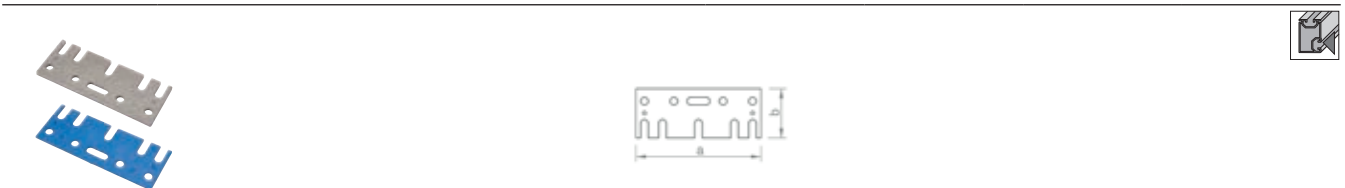

Shim for side-fix roof hooks for height compensation between the roof hook and the roof batten.

Item no.	Designation	a in mm	b in mm	c in mm	Material
03-000979	Shim for roof hook PP blue, 2mm				PP
03-000980	Shim for roof hook PP grey, 5mm				PP

Roof attachment

Roof hook mounting screws



6 mm wood screw with flange head and Torx drive 25, can be used for various roof hooks.

Art.-Nr. Item no.	Designation	a in mm	b in mm	c in mm	Material
03-000268	Roof hook mounting screw 6 × 30	30	6		St. galv.
03-000269	Roof hook mounting screw 6 × 60	60	6		St. galv.
03-000271	Roof hook mounting screw 6 × 90	90	6		St. galv.
03-000272	Roof hook mounting screw 6 × 120	120	6		St. galv.
03-000273	Roof hook mounting screw 6 × 150	150	6		St. galv.
03-000270	Roof hook mounting screw 6 × 30 A2SS	30	6		A2SS
03-000274	Roof hook mounting screw 6 × 60 A2SS	60	6		A2SS
03-000278	Roof hook mounting screw 6 × 90 A2SS	90	6		A2SS
03-000279	Roof hook mounting screw 6 × 120 A2SS	120	6		A2SS
03-000280	Roof hook mounting screw 6 × 150 A2SS	150	6		A2SS

Roof hook mounting screws

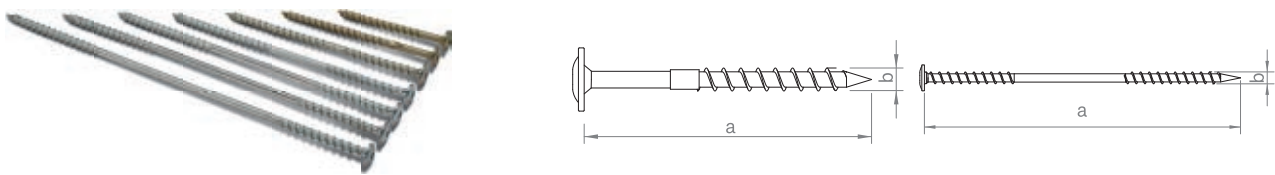

8 mm wood screw with flange head and Torx drive 40, can be used for various roof hooks, with underhead thread for lengths longer than 180 mm.

Item no.	Designation	a in mm	b in mm	c in mm	Material
03-000281	Roof hook mounting screw 8 × 100	100	8		St. galv.
03-000282	Roof hook mounting screw 8 × 140	140	8		St. galv.
03-000283	Roof hook mounting screw 8 × 180	180	8		St. galv.
03-000303	Roof hook mounting screw 8 × 220	220	8		St. galv.
03-000304	Roof hook mounting screw 8 × 260	260	8		St. galv.
03-000305	Roof hook mounting screw 8 × 300	300	8		St. galv.
03-000306	Roof hook mounting screw 8 × 340	340	8		St. galv.

Roof hook mounting screw



Wood screw countersunk with AW drive 30, can be used for roof hook S C-shape.

Item no.	Designation	a in mm	b in mm	c in mm	Material
03-000486	Roof hook mounting screw 6x80 countersunk	80	6		A2SS

Roof attachment

Direct mounting screws trapezoidal sheet

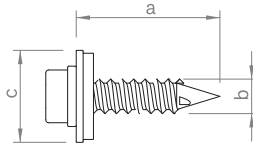

Thin sheet screw for chipless attachment of short rails on the trapezoidal sheet, with 16 mm or 11 mm sealing washer depending on the fixing variation on the raised bead, 8 AF hexagon drive.

Item no.	Designation	a in mm	b in mm	c in mm	Material
03-000880	Trapez. mounting screw cl 6.0 x 25 E16	25	6	16	A2SS
03-000893	Trapez. mounting screw cl 5.5 x 25 E11	25	5.5	11	A2SS

Direct mounting set trapezoidal sheet

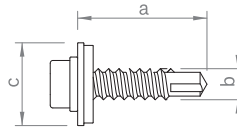

Mounting set consisting of 2 self-drilling screws with 8 AF hexagon drive and an EPDM sealant strip 130®x®45 mm for fixing base profiles on the trapezoidal sheet.

Item no.	Designation	a in mm	b in mm	c in mm	Material
03-000062	Direct base profile mounting set	25	6	16	V2SS/EPDM

Indirect mounting set base profile

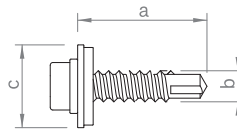

Mounting set consisting of 4 self-drilling screws with 8 AF hexagon drive for fixing the base profile on the C-rail.

Item no.	Designation	a in mm	b in mm	c in mm	Material
03-000065	Indirect mounting set for base profile	25	6	16	A2SS

Roof attachment

Direct mounting set trapezoidal sheet

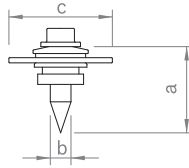

Mounting set for chipless fixing of C-rails on the trapezoidal sheet, pre-assembled thin sheet screw with washer and EPDM seal, 8 AF hexagon drive.

Item no.	Designation	a in mm	b in mm	c in mm	Material
03-000197	C-rail direct mounting set cl	25	6	30	A2SS/EPDM

Trapezoidal sheet brackets

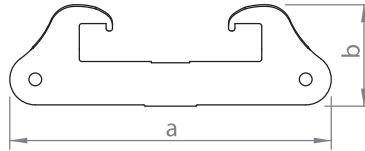

Bracket with EPDM seal for fixing insertion rails on trapezoidal sheet, with two thin sheet screws with 8 AF hexagon drive, for bead heights from 25 mm or 35 mm, for framed or frameless module insertion rails.

Item no.	Designation	a in mm	b in mm	c in mm	Material
03-000459	Trapezoidal sheet bracket IR set 40 × 126 mm	126	40		V2A
03-000451	Trapezoidal sheet bracket IR FL set 45 × 141 mm	141	45		V2A

Roof attachment

Stock screws (for wood)

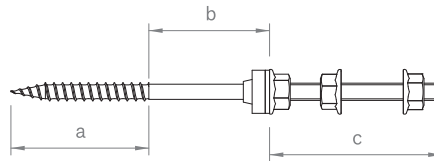

Stock screw for timber purlins with hexagon drive 7 AF or 9 AF, for mounting C-rails or base plates, pre-assembled with EPDM seal and 18 AF locking nuts. Alternative packing units see p. 86.

Item no.	Designation	a in mm	b in mm	c in mm	Material
03-000222	Stock screw set (for wood) M10 200 mm	75	25	100	A2SS / EPDM
03-000223	Stock screw set (for wood) M10 250 mm	75	75	100	A2SS / EPDM
03-000224	Stock screw set (for wood) M10 300 mm	75	75	150	A2SS / EPDM
03-000211	Stock screw set (for wood) M12 200 mm	75	25	100	A2SS / EPDM
03-000210	Stock screw set (for wood) M12 250 mm	75	75	100	A2SS / EPDM
03-000216	Stock screw set (for wood) M12 300 mm	75	75	150	A2SS / EPDM

Stock screws (for wood)

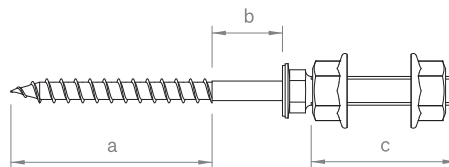

Stock screw for timber purlins with hexagon drive 5 AF, for mounting C-rails or base plates, with 18 AF locking nuts, combinable with EPDM round seal d = 25 mm.

Item no.	Designation	a in mm	b in mm	c in mm	Material
03-000894	Stock screw set (for wood) 8,4-M10 160 mm	70	10	70	A2SS
03-000895	Stock screw set (for wood) 8,4-M10 190 mm	90	20	70	A2SS
03-000940	Stock screw set (for wood) 8,4-M10 210 mm	100	30	70	A2SS
03-000941	Stock screw set (for wood) 8,4-M10 240 mm	120	40	70	A2SS
03-000942	Stock screw set (for wood) 8,4-M10 260 mm	130	50	70	A2SS

Stock screws (for steel)

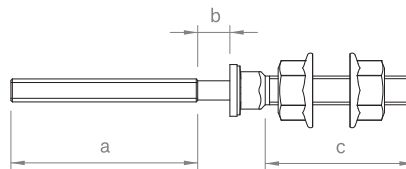

Stock screw for steel purlins with hexagon drive 5 AF, for mounting C-rails or base plates, with 18 AF locking nuts, combinable with EPDM round seal d = 25 mm. Alternative packing units see p. 86.

Item no.	Designation	a in mm	b in mm	c in mm	Material
03-000199	Stock screw set (for steel) 8,0-M10 140 mm	65	10	50	A2SS
03-000202	Stock screw set (for steel) 8,0-M10 185 mm	65	55	50	A2SS
03-000203	Stock screw set (for steel) 8,0-M10 220 mm	65	90	50	A2SS
03-000943	Stock screw set (for steel) 8,0-M10 260 mm	65	130	50	A2SS

Roof attachment

Standing seam clamp



Clamp with grub screw for standing seam roofs and an 18 AF locking nut for fixing C-rails, optionally with stainless steel saddle for mounting on copper roofs. Alternative packing units see p. 86.

Item no.	Designation	a in mm	b in mm	c in mm	Material
03-000219	Standing seam clamp set M8	7,4	30	17	Alu / A2SS
03-000369	Standing seam clamp set M8 for copper	7,4	30	17	Alu / A2SS

Standing seam clamp insertion system

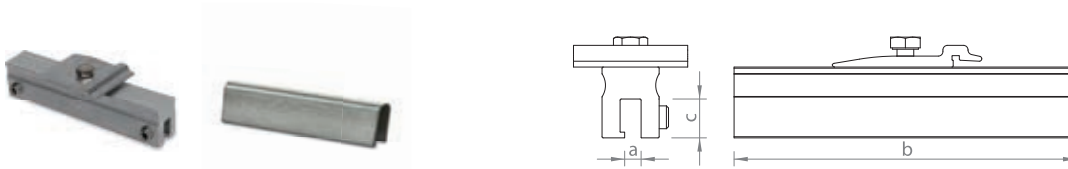

Clamp with grub screws for standing seam roofs, grub screw with hexagon AF 5 drive, pre-assembled with cross rail connector IR and hexagon screw AF 13 for direct fixing of insertion rails. An additional stainless steel saddle is required for mounting on copper roofs. Alternative packing units see p. 86.

Item no.	Designation	a in mm	b in mm	c in mm	Material
03-001028	Standing seam clamp set 150 M8 IR	7,4	150	17	Alu / A2SS
03-001135	A2SS-saddle for standing seam clamp 150	7,4	150	17	A2SS
03-001466	Standing seam clamp set 150 IR M8 for copper	7,4	150	17	Alu / A2SS

Rounded seam clamp



Clamp with grub screw and cylinder head screw with hexagon drive AF 5 for round seam roofs and an 18 AF locking nut for fixing C-rails. Alternative packing units see p. 86.

Item no.	Designation	a in mm	b in mm	c in mm	Material
03-001069	Rounded seam clamp set M8	24	30	36	Alu / A2SS

Profile rails

C-rails

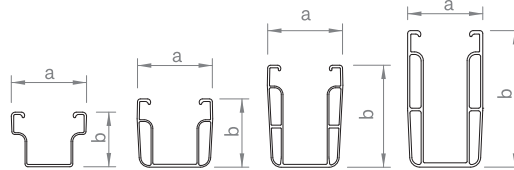

Mounting rail with cable channel, for use as a module support rail in clamping systems or as a cross rail, available in different dimensions for various spans and loads depending on structural requirements. Rail bottom with slots 75 x 15 mm in 100 mm grid for easy fixing from above, available in blank or black anodised variations.

Item no.	Designation	a in mm	b in mm	c in mm	Material
03-001362	C-rail 38-1,6 2.20 m	52	38		Alu
03-001364	C-rail 38-1,6 5.40 m	52	38		Alu
03-001441	C-rail 47-2 2.40 m	52	47		Alu
03-001366	C-rail 47-2 2.20 m	52	47		Alu
03-001368	C-rail 47-2 4.30 m	52	47		Alu
03-001369	C-rail 47-2 5.40 m	52	47		Alu
03-001371	C-rail 71-2 5.40 m	52	71		Alu
03-001372	C-rail 95-3 5.40 m	52	95		Alu
03-001363	C-rail 38-1,6 2.20 m black	52	38		Alu
03-001365	C-rail 38-1,6 5.40 m black	52	38		Alu
03-001367	C-rail 47-2 2.20 m black	52	47		Alu
03-001370	C-rail 47-2 5.40 m black	52	47		Alu

C-N-rail

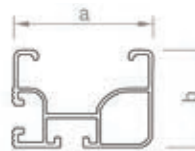

Mounting rail with cable channel and groove, for use as a module support rail in clamping systems or as a cross rail, side groove with fluting for easy fixing from the side, available in blank or black anodised variations.

Item no.	Designation	a in mm	b in mm	c in mm	Material
03-001413	C-N-rail 37 2.20 m	52	37		Alu
03-001328	C-N-rail 37 5.40 m	52	37		Alu
03-001414	C-N-rail 37 2.20 m black	52	37		Alu
03-001412	C-N-rail 37 5.40 m black	52	37		Alu

N-rails

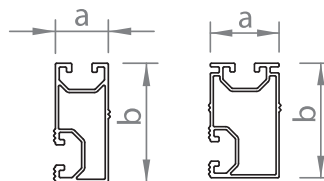

Mounting rail with groove for use as a cross rail, available in different dimensions for various spans and loads depending on structural requirements, side groove with fluting for easy fixing from the side.

Item no.	Designation	a in mm	b in mm	c in mm	Material
03-001403	N-rail Eco 22 x 50 5.40 m	22	50		Alu
03-001404	N-rail Standard 30 x 50 5.40 m	30	50		Alu

Profile rails

Short rails trapezoidal metal sheet module landscape

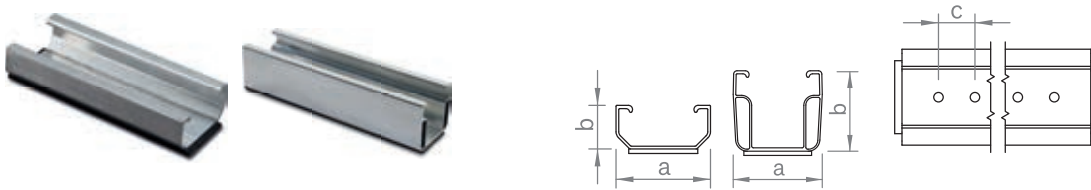

Short rail with 5.2 mm perforation and pre-assembled sealant strip for mounting modules in landscape on trapezoidal sheet. Chipless mounting is accomplished using the trapezoidal sheet mounting screw.

Item no.	Designation	a in mm	b in mm	c in mm	Material
03-000841	Short rail C24 with EPDM 125mm	52	24	20	Alu / EPDM
03-001108	Short rail C47 with EPDM 200mm	52	47	20	Alu / EPDM

Short rails corrugated metal sheet module landscape

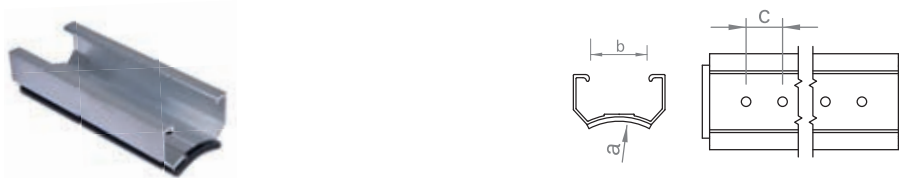

Short rail with 5.2 mm perforation and pre-assembled sealant strip for mounting modules in landscape on corrugated sheet, radius 39.4 mm. Chipless mounting is accomplished using the trapezoidal sheet mounting screw.

Item no.	Designation	a in mm	b in mm	c in mm	Material
03-001223	Short rail C33 R39.4 with EPDM 125mm	39,4	33	20	Alu / EPDM

Short rail trapezoidal and corrugated metal sheet module portrait

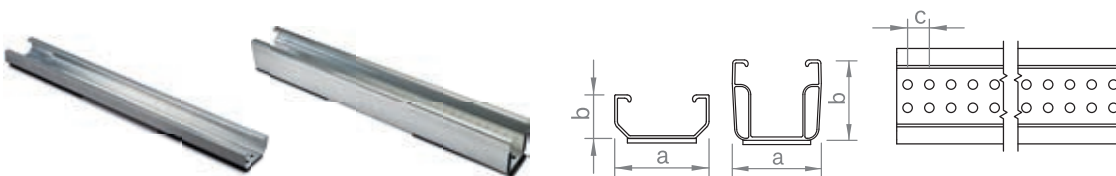

Short rail with 5.2 mm perforation and pre-assembled sealant strip for mounting modules in portrait on trapezoidal or corrugated sheet. Chipless mounting is accomplished using the trapezoidal sheet mounting screw.

Item no.	Designation	a in mm	b in mm	c in mm	Material
03-001081	Short rail C24 with EPDM 385mm	52	24	12	Alu / EPDM
03-000873	Short rail C47 with EPDM 385mm	52	47	12	Alu / EPDM

Profile connectors and expansion joints

Rail connector C-rail 38

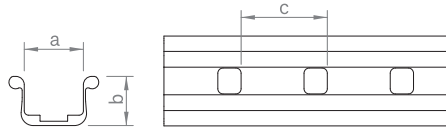

Connector C-rail 38, l = 325 mm, with two round-head screws and locking nuts with 18 AF hexagon drive, available as expansion joint construction with four round-head screws. Alternative packing units see p. 87.

Item no.	Designation	a in mm	b in mm	c in mm	Material
03-001105	Rail connector set C38	35	28.5	50	Alu / A2SS
03-001106	Expansion joint C38	35	28.5	50	Alu / A2SS

Rail connector C-rail 47 profile chambers

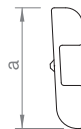

Connector C-rail 47, l = 200 mm, screw connection with four self-drilling screws with 8 AF hexagon drive. Alternative packing units see p. 87.

Item no.	Designation	a in mm	b in mm	c in mm	Material
03-000925	Rail connector set C47 S	30			Alu / A2SS

Rail connector C-rail 47

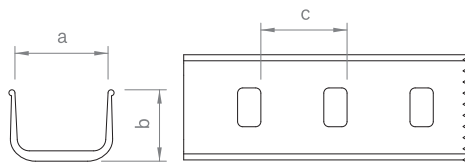

Connector C-rail 47, l = 325 mm, with two round-head screws and locking nuts with 18 AF hexagon drive, available as expansion joint construction with four round-head screws. Alternative packing units see p. 87.

Item no.	Designation	a in mm	b in mm	c in mm	Material
03-000001	Rail connector set C47	52	40	50	Alu / A2SS
03-000138	Expansion joint C47	52	40	50	Alu / A2SS

Rail connector C-rail 71

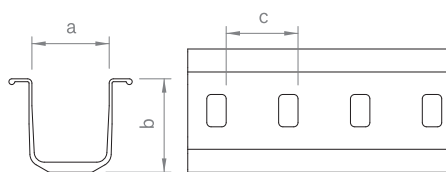

Connector C-rail 71, l = 490 mm, with four round-head screws, washers and locking nuts with 18 AF hexagon drive, available as expansion joint construction. Alternative packing units see p. 87.

Item no.	Designation	a in mm	b in mm	c in mm	Material
03-000151	Rail connector set C71	52	67	50	Alu / V2A
03-000265	Expansion joint C71	52	67	50	Alu / V2A

Profile connectors and expansion joints

Rail connector C-rail 95

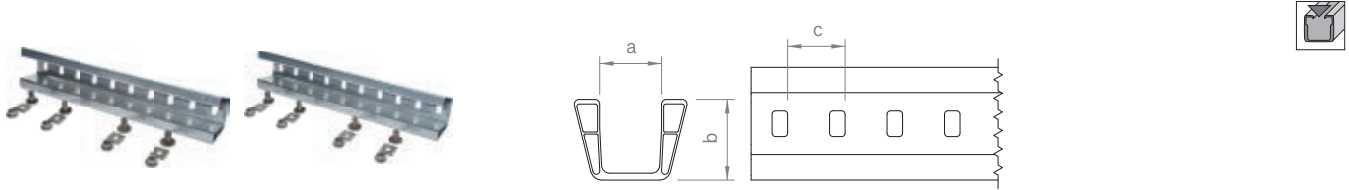

Connector C-rail 95, l = 500 mm, with four round-head screws, washers and locking nuts with 18 AF hexagon drive, available as expansion joint construction. Alternative packing units see p. 87.

Item no.	Designation	a in mm	b in mm	c in mm	Material
03-000130	Rail connector set C95	52	70	50	Alu/V2A
03-000173	Expansion joint C95	52	70	50	Alu/V2A

Rail connector C-N-rail 37



Connector C-N-rail 37, l = 250 mm, screw connection with two thin sheet screws with 8 AF hexagon drive.

Item no.	Designation	a in mm	b in mm	c in mm	Material
03-001347	Rail connector set C-N 37 S	17,5	19	250	Alu/V2A

Rail connector N-rail

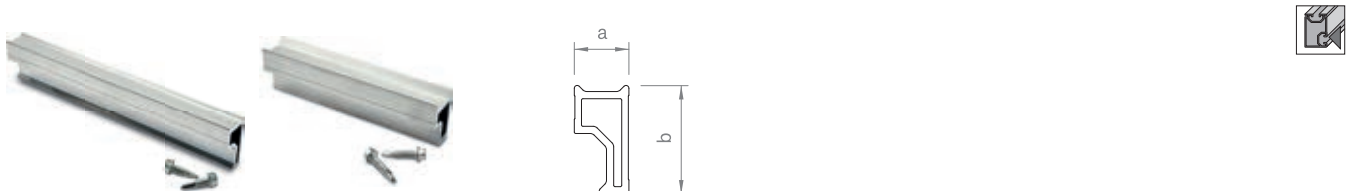

Connector N-rail, l = 200 mm or l = 150 mm, screw connection with two self-drilling screws with 8 AF hexagon drive.

Item no.	Designation	a in mm	b in mm	c in mm	Material
03-000500	Rail connector set N Eco	19	38	200	Alu/V2A
03-000524	Rail connector set N Standard	27	41	150	Alu/V2A

Profile connectors and expansion joints

Rail connector elevation profile pair H45

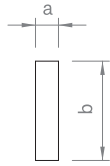

Connector elevation profile pair H45, l = 160 mm.

Item no.	Designation	a in mm	b in mm	c in mm	Material
03-000496	Rail connector set elevation profile pair H45	5	22		Alu

Rail connector elevation profile pair H136



Connector elevation profile pair H136, l = 150 mm, screw connection with four thin sheet screws with 8 AF hexagon drive.

Art.-Nr.	Designation	a in mm	b in mm	c in mm	Material
03-000525	Rail connector set elevation profile pair H136	12	50		Alu / V2A

Cross rail connector

Connection insertion rail on C-rail and C-N-rail

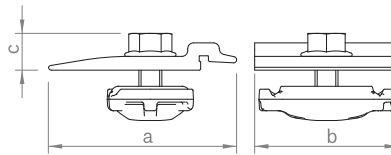

Connector for fixing insertion rails on C-rails and mounting triangles, locking nut with 13 AF hexagon drive, completely pre-assembled.

Item no.	Designation	a in mm	b in mm	c in mm	Material
03-000321	Cross rail connector set C IR M8	66	50	13	Alu / A2SS

Connection insertion rail on N-rail

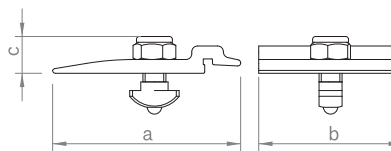

Connector for fixing insertion rails on N-rails, slot bolt M8 and locking nut with 13 AF hexagon drive, completely pre-assembled.

Item no.	Designation	a in mm	b in mm	c in mm	Material
03-000409	Cross rail connector set N IR M8	66	50	13	Alu / A2SS

Connection C-rail on C-rail or C-N-rail

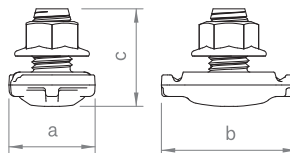

Connector for fixing C-rails to create a cross rail configuration, locking nut M14 with 18 AF hexagon drive. Alternative packing units see p. 87.

Item no.	Designation	a in mm	b in mm	c in mm	Material
03-000226	Cross rail connector set C M14	30	46	34	Alu / A2SS

Connection N-rail on N-rail

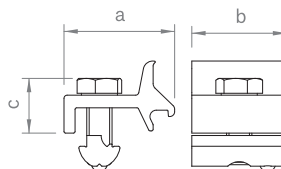

Connector for fixing C-N-rail or N-rails to create a cross rail configuration, slot bolt M8 13 AF hexagon drive and slot nut, l = 30 mm or l = 65 mm.

Item no.	Designation	a in mm	b in mm	c in mm	Material
03-000599	Cross rail connector set N 30 mm M8	35	30	22	Alu / A2SS
03-000904	Cross rail connector set N 65 mm M8	35	65	22	Alu / A2SS

Module protection and rail top cover

Top cover C-rail and C-N-rail

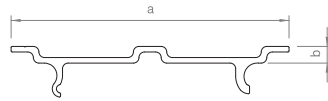

Cover to clip on to the C-rail and C-N-rail if using as cable channel, available in blank or black anodised variations.

Item no.	Designation	a in mm	b in mm	c in mm	Material
03-000134	Top cover C-rail / C-N-rail 2.00 m	50	3		Alu
03-001469	Top cover C-rail / C-N-rail 2.00 m black	50	3		Alu

End caps C-rail

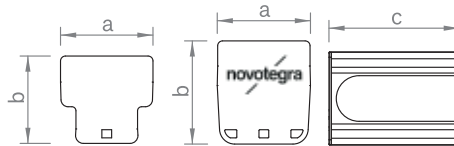

End cap in black for C-rail 38 and C-rail 47, UV and weather resistant.

Item no.	Designation	a in mm	b in mm	c in mm	Material
03-001110	End cap C-rail C38 black	57	54	80	PP
03-001111	End cap C-rail C47 black	57	63	80	PP

End cap C-N-rail

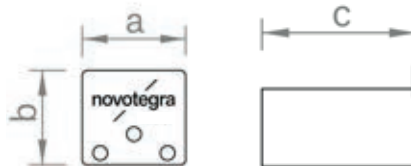

End cap in black for C-N-rail 37, UV and weather resistant.

Item no.	Designation	a in mm	b in mm	c in mm	Material
03-001343	End cap C-N 37 black	57	52	80	PP

End caps N-rail

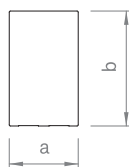

End cap in black for N-rails, UV and weather resistant.

Item no.	Designation	a in mm	b in mm	c in mm	Material
03-000527	End cap N-rail Eco	22	50		PA 6.6
03-000529	End cap N-rail Standard	30	50		PA 6.6

Module protection and rail top cover

Slip guards and end caps C-rail



Slip guard for fixing modules mounted in landscape or as an end cap for the C-rail, available in blank or black. Alternative packing units see p. 87.

Item no.	Designation	a in mm	b in mm	c in mm	Material
03-000259	Slip guard/ End cap set C47	53	80	80	Alu / A2SS
03-000261	Slip guard/ End cap set C71	53	100	80	Alu / A2SS
03-000263	Slip guard/ End cap set C95	53	130	80	Alu / A2SS
03-000260	Slip guard/ End cap set C47 black	53	80	80	Alu / A2SS
03-000262	Slip guard/ End cap set C71 black	53	100	80	Alu / A2SS
03-000264	Slip guard/ End cap set C95 black	53	130	80	Alu / A2SS

Slip guard short profile trapezoidal short rail

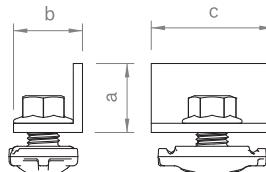

Slip guard with 18 AF locking nut for securing the modules mounted in landscape on short rails.

Item no.	Designation	a in mm	b in mm	c in mm	Material
03-000233	Slip guard set for short rail profile M14	30	30	53	Alu / A2SS

Module slip guards portrait orientation

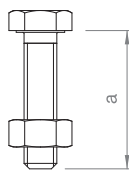

Slip guard for fixing modules with and without mounting holes for mounting modules in portrait. Alternative packing units see p. 87.

Item no.	Designation	a in mm	b in mm	c in mm	Material
03-000006	Module slip guard set M6	25			V2A
03-000007	Module slip guard set M8	25			V2A
03-000372	Module slip guard set box frame	20			V2A

Module protections insertion rail

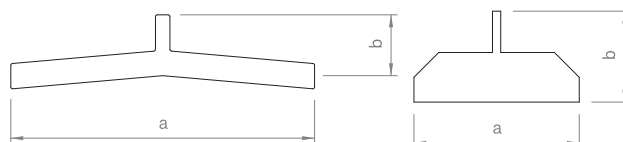

EPDM-T protection for fixing modules in insertion rails with minimal module slope ($< 10^\circ$), for framed or unframed modules. Can be used as an anti-theft device.

Item no.	Designation	a in mm	b in mm	c in mm	Material
03-000631	EPDM-T protection IR	84	17		EPDM
03-000630	EPDM-T protection IR FL	40	22		EPDM

Module protection and rail top cover

Edge stop elevation profile pair

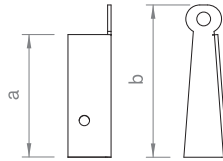

Edge stop for elevation profile pair H136, fixing with 8 AF hexagon drive thin sheet screw.

Item no.	Designation	a in mm	b in mm	c in mm	Material
03-000593	Edge stop set elevation profile pair H136	71	88		Alu / A2SS

Module elevation

Elevation profile pairs

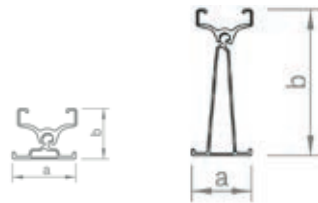
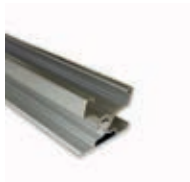

Articulated jointed rail pairs as foot and head rails, for variable module elevation at an angle of approx. 3 – 18° by combining two rail pairs.

Item no.	Designation	a in mm	b in mm	c in mm	Material
03-000646	Elevation profile pair H45 6.00m	56	45		Alu
03-000470	Elevation profile pair H136 6.00m	56	136		Alu

Base profile elevation

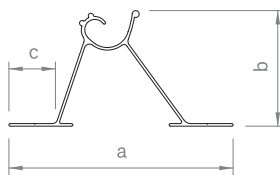

Module support rail for module elevation on flat roofs as well as for trapezoidal sheet, corrugated and sandwich roofs.

Item no.	Bezeichnung	a in mm	b in mm	c in mm	Material
03-000193	Base profile 6.12m	130	67	27	Alu
03-000194	Base profile 5.06m	130	67	27	Alu
03-000195	Base profile 3.37m	130	67	27	Alu

Module elevation

Module bracket front mounting hole

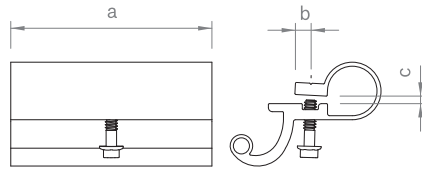

Front module support for flat roof system generation I or elevation on pitched roof, to connect to the module frame holes, completely pre-assembled.

Item no.	Designation	a in mm	b in mm	c in mm	Material
03-000078	Module bracket set front	100	8	4	Alu / A2SS

Module bracket set direct box frame

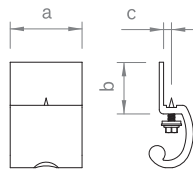

Front module support for flat roof system generation I or elevation on pitched roof, to directly connect to the module frame without frame holes, completely pre-assembled.

Item no.	Designation	a in mm	b in mm	c in mm	Material
03-000239	Module bracket set front direct (box fr.)	50	36	5,5	Alu / A2SS

Module bracket back mounting hole

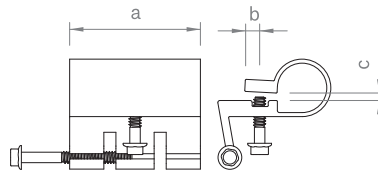

Rear module support for flat roof system open or elevation on pitched roof, to connect to the module frame holes, completely pre-assembled.

Item no.	Designation	a in mm	b in mm	c in mm	Material
03-000061	Module bracket set back	65	8	4	Alu / A2SS

Module support 13° - 40° open

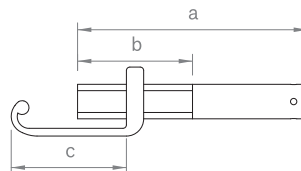

Rear module support for flat roof system open or elevation on pitched roof, in different lengths to elevate modules, continuous adjustable elevation angle, completely pre-assembled.

Item no.	Designation	a in mm	b in mm	c in mm	Material
03-000070	Module support set 200mm	200	100	100	Alu
03-000071	Module support set 280mm	280	100	100	Alu
03-000083	Module support set 360mm	360	100	100	Alu
03-000022	Module support set 440mm	440	100	100	Alu
03-000072	Module support set 520mm	520	100	100	Alu

Module attachment

Middle clamps C-rail and C-N-rail

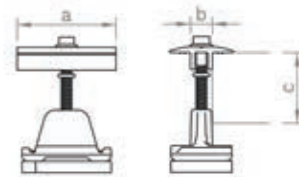

Middle clamp for fixing the modules on the C-rail or C-N-rail. Installation-friendly thanks to click-in mechanism. Clamping screw with 8 AF hexagon drive. For frame heights of 30–42 mm or 43–52 mm, available in blank or black anodised variations.

Item no.	Designation	a in mm	b in mm	c in mm	Material
03-001345	Middle clamp 30-42 Set C	52	11,4	30–42	Alu / A2SS / PE
03-000285	Middle clamp 43-52 Set C	52	11,4	43–52	Alu / A2SS / PE
03-001346	Middle clamp 30-42 Set C black	52	11,4	30–42	Alu / A2SS / PE
03-000286	Middle clamp 43-52 Set C black	52	11,4	43–52	Alu / A2SS / PE

End clamps C-rail and C-N-rail

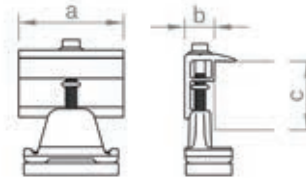

End clamp for fixing the modules on the C-rail or C-N-rail. Installation-friendly thanks to click-in mechanism. Clamping screw with 8 AF hexagon drive. For frame heights of 30–42 mm or 43–52 mm, available in blank or black anodised variations.

Item no.	Designation	a in mm	b in mm	c in mm	Material
03-001236	End clamp 30-42 Set C	52	14	30–42	Alu / A2SS / PE
03-000287	End clamp 43-52 Set C	52	14	43–52	Alu / A2SS / PE
03-001237	End clamp 30-42 Set C black	52	14	30–42	Alu / A2SS / PE
03-000288	End clamp 43-52 Set C black	52	14	43–52	Alu / A2SS / PE

Middle clamp frameless 6.8 - 8.0 C-rail and C-N-rail

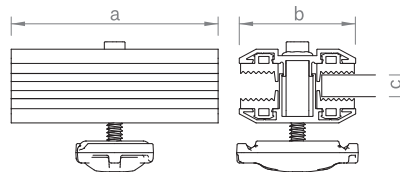

Middle clamp for fixing frameless modules on the C-rail or C-N-rail, permissible glass thickness 6.8–8.0 mm, completely pre-assembled. Clamping screw with AF 8 hexagon drive.

Item no.	Designation	a in mm	b in mm	c in mm	Material
03-000312	Middle clamp FL 6.8-8.0 mm Set C	80	45	6,8–8,0	Alu / EPDM

End clamp frameless 6.8 – 8.0 C-rail and C-N-rail

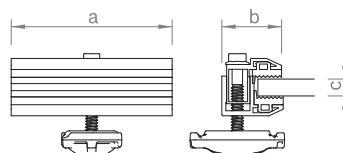

End clamp for fixing frameless modules on the C-rail or C-N-rail, permissible glass thickness 6.8–8.0 mm, completely pre-assembled. Clamping screw with AF 8 hexagon drive.

Item no.	Designation	a in mm	b in mm	c in mm	Material
03-000317	End clamp FL 6.8 – 8.0 mm Set C	80	30,5	6,8–8,0	Alu / EPDM

Module attachment

Insertion rails framed modules



Insertion rail for inserting framed modules with a frame height of 30 - 50 mm, available in blank or black anodised variations. The actual frame height of the module corresponds to the specified dimension b minus 1.3 mm.

Item no.	Designation	a in mm	b in mm	c in mm	Material
03-001416	Insertion rail 30 5.40m	56	31,3	50	Alu
03-001373	Insertion rail 32 5.40m	56	33,3	52	Alu
03-001375	Insertion rail 35 2.20m	56	36,3	55	Alu
03-001379	Insertion rail 35 5.40m	56	36,3	55	Alu
03-001381	Insertion rail 36 5.40m	56	37,3	56	Alu
03-001383	Insertion rail 38 5.40m	56	39,3	58	Alu
03-001385	Insertion rail 40 2.20m	56	41,3	60	Alu
03-001387	Insertion rail 40 5.40m	56	41,3	60	Alu
03-001389	Insertion rail 41 5.40m	56	42,3	61	Alu
03-001391	Insertion rail 42 5.40m	56	43,3	62	Alu
03-001393	Insertion rail 43 5.40m	56	44,3	63	Alu
03-001395	Insertion rail 45 5.40m	56	46,3	65	Alu
03-001397	Insertion rail 46 5.40m	56	47,3	66	Alu
03-001399	Insertion rail 50 5.40m	56	51,3	70	Alu
03-001417	Insertion rail 30 5.40m black	56	31,3	50	Alu
03-001374	Insertion rail 32 5.40m black	56	33,3	52	Alu
03-001378	Insertion rail 35 2.20m black	56	36,3	55	Alu
03-001380	Insertion rail 35 5.40m black	56	36,3	55	Alu
03-001382	Insertion rail 36 5.40m black	56	37,3	56	Alu
03-001384	Insertion rail 38 5.40m black	56	39,3	58	Alu
03-001386	Insertion rail 40 2.20m black	56	41,3	60	Alu
03-001388	Insertion rail 40 5.40m black	56	41,3	60	Alu
03-001390	Insertion rail 41 5.40m black	56	42,3	61	Alu
03-001392	Insertion rail 42 5.40m black	56	43,3	62	Alu
03-001394	Insertion rail 43 5.40m black	56	44,3	63	Alu
03-001396	Insertion rail 45 5.40m black	56	46,3	65	Alu
03-001398	Insertion rail 46 5.40m black	56	47,3	66	Alu
03-001400	Insertion rail 50 5.40m black	56	51,3	70	Alu

Insertion rails Plus snow guard

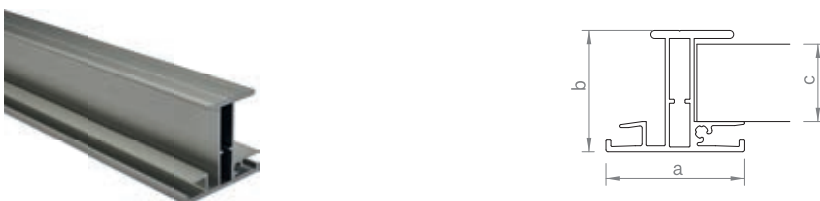

Insertion rail for inserting framed modules with a frame height of 35 mm or 40 mm for heavy snow loads, with the option of attaching a snow guard system.

Item no.	Designation	a in mm	b in mm	c in mm	Material
03-001401	Insertion rail Plus 35 5.40m	69	55	35	Alu
03-001402	Insertion rail Plus 40 5.40m	69	62	40	Alu

Module attachment

Rail connector insertion rail



Connector insertion rail for framed modules, l = 150 mm, available in blank or black anodised variations.

Item no.	Designation	a in mm	b in mm	c in mm	Material
03-000648	Rail connector set IR	65	18		Alu / A2SS
03-000499	Rail connector set IR black	65	18		Alu / A2SS

Rail connector insertion rail trapezoidal sheet bracket and seamed metal roof



Connector insertion rail for framed modules, l = 100^ømm, for direct mounting on trapezoidal sheet.

Item no.	Designation	a in mm	b in mm	c in mm	Material
03-000647	Rail connector IR 5 x 100 A2SS	5			A2SS

Rail connector insertion rail Plus



Connector insertion rail Plus for framed modules, l = 200 mm.

Item no.	Designation	a in mm	b in mm	c in mm	Material
03-000471	Rail connector set IR Plus	10	30		Alu

Rail connector snow guard insertion rail Plus



Connector for snow guard stop IR 20 x 5, l = 200 mm.

Item no.	Designation	a in mm	b in mm	c in mm	Material
03-000494	Rail connector set snow guard IR	8			Alu

Module attachment

Support rail module insertion system

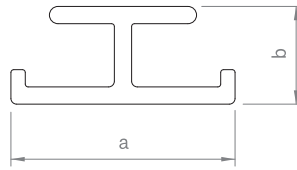

Support rail to brace modules between the insertion rails of a module row in case of heavy snow loads.

Item no.	Designation	a in mm	b in mm	c in mm	Material
03-001442	Support rail IR 5.40 m	39	17		Alu

Snowguard insertion system

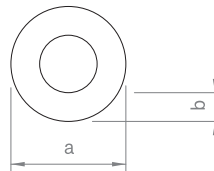

Round pipe in combination with the mounting set snow guard for use on insertion rail Plus as a snow stop system.

Item no.	Designation	a in mm	b in mm	c in mm	Material
03-000406	Snow guard IR 20 x 5 Alu round pipe 6.00 m	20	5		Alu
03-000408	Snow guard IR 20 x 5 Alu round pipe 0.80 m	20	5		Alu

Mounting set snowguard insertion rail



Bracket with grub screw for fixing the snow guard.

Item no.	Designation	a in mm	b in mm	c in mm	Material
03-000476	Mounting set snowguard IR				A2SS

Module protection and rail top cover

Edge stops insertion rail



Edge stop for insertion rails, fixing with tapping screw Torx drive 30.

Item no.	Designation	a in mm	b in mm	c in mm	Material
03-000691	Edge stop set IR	49	49		Alu / A2SS
03-000693	Edge stop set IR black	49	49		Alu / A2SS

Edge stop insertion rail Plus



Edge stop for insertion rails Plus, fixing with self-drilling screw Torx drive 30.

Item no.	Designation	a in mm	b in mm	c in mm	Material
03-000732	Edge stop set IR Plus	75	75		Alu / A2SS

Accessories and optional components

Connector optimizer



Connector set for fixing parts as optimizers to the C-rail, C-N-rail or short rail.

Item no.	Designation	a in mm	b in mm	c in mm	Material
03-000329	Mounting Set C-Rail M8				Alu / A2SS
03-000373	Plate 50x50x3 D8,5 Alu				Alu

Slot nut side-fix



For connecting C-N-rails or N-rails to the roof hook side-fix.

Item no.	Designation	a in mm	b in mm	c in mm	Material
03-000589	Slot nut A2SS with spring ball M8 30 mm				A2SS
03-000600	Slot nut Alu with spring ball M8 22 mm				A2SS

Slot nut



For connecting C-N-rails or N-rails to the roof hook side-fix.

Item no.	Designation	a in mm	b in mm	c in mm	Material
03-000682	Slot bolt M8 with serrated locking nut				A2SS

Slot nut set



For connecting C-N-rails or N-rails to the roof hook side-fix.

Item no.	Designation	a in mm	b in mm	c in mm	Material
03-000683	Slot nut set with screw M8x18 A2SS				A2SS
03-000684	Slot nut set with screw M8x16 A2SS				A2SS

Accessories and optional components

Contact latch module clamp



Contact latch for equipotential bonding / lightning current carrying capacity between module frame and mounting system. Suitable for all middle clamps of pitched roof and flat roof II.

Item no.	Designation	a in mm	b in mm	c in mm	Material
03-001185	Contact latch module clamp	20	24	10	A2SS

Grounding connector C-rail



Grounding connector set sufficient for clamping cables of 6-16 mm² or wire with diameter 6-10mm.

Item no.	Designation	a in mm	b in mm	c in mm	Material
03-000012	Grounding connector C-rail				A2SS

Grounding connector C-N-rail / N-rail



Grounding connector set sufficient for clamping cables of 6 - 50 mm² or wire with diameter 2,8 - 8 mm.

Item no.	Designation	a in mm	b in mm	c in mm	Material
03-001437	Grounding connector C-N-rail / N-rail				A2SS

L adapter set



L adapter set for fixing N-rails to C-shaped hooks.

Item no.	Designation	a in mm	b in mm	c in mm	Material
03-000530	L adapter set N-rail to C-shape roof hook				Alu / A2SS

Accessories and optional components

Metal shingle

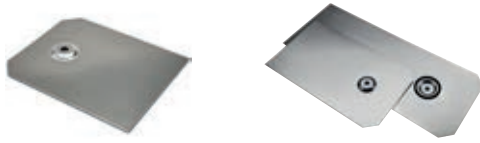

Aluminium metal shingle with sealing for shingle roofing e. g. bitumen, fibre cement or slate, in use in combination with stock screws.

Item no.	Designation	a in mm	b in mm	c in mm	Material
03-000535	Metal shingle 280x230 mm, with sealing				Alu / EPDM
03-000536	Metal shingle 390 x 230 mm, with sealing				Alu / EPDM
03-000537	Metal shingle 580 x 230 mm, with sealing				Alu / EPDM

Clip



Cable clip, for cable bundle up to 10 mm diameter, with clip to connect to the module frame or similar.

Item no.	Designation	a in mm	b in mm	c in mm	Material
03-000099	Cable clip d=10mm				PA
03-000510	Cable collector N-rail PA 4 cables				PP

Cable tie with and without clip



Black polyamide plastic, UV-resistant for tool-free fastening on rails, for 1-3 mm or 3-6 mm metal flange.

Item no.	Designation	a in mm	b in mm	c in mm	Material
03-000504	Cable-tie black, 140 mm				PP
03-000505	Cable-tie black, 200 mm				PP
03-000506	Cable-tie black, 280 mm				PP
03-000507	Cable-tie black, 360 mm				PP
03-000508	Cable-tie clip for profile flange 1 - 3 mm				PP
03-000509	Cable-tie clip for profile flange 3 - 6 mm				PP

Accessories and optional components

EPDM sealant strip



EPDM sealant stripe as a safety and sealant layer below the C-rail on trapezoidal roofs.

Item no.	Designation	a in mm	b in mm	c in mm	Material
03-000082	EPDM sealant strip for C-rail 50x35 mm				EPDM

EPDM tape



EPDM tape as a protection layer below insertion rails on trapezoidal. To use in combination with trapezoidal sheet bracket.

Item no.	Designation	a in mm	b in mm	c in mm	Material
03-000627	EPDM tape 10.000 x 54 x 3 mm IR				EPDM

EPDM sealant strip



EPDM tape as a protection layer below insertion rails on trapezoidal, 100 pcs per roll.

Item no.	Designation	a in mm	b in mm	c in mm	Material
03-000633	EPDM sealant strip 70 x 28 x 2 mm IR				EPDM

EPDM round seal



EPDM round sealant d = 25mm in use with the stock screw set (for wood) 8.4 M10 respectively stock screw set (for steel) 8.0 M10.

Item no.	Designation	a in mm	b in mm	c in mm	Material
03-000184	EPDM round seal d = 25mm				EPDM

Alternative packing units

Roof attachment

The following novotegra articles are also available in alternative, smaller packing units (PU):

Art.-Nr.	Bezeichnung	VPE Standard	VPE Alternativ	Art.-Nr.	Produktdetails
03-000258	Roof hook set BS 30 M12	50	5	03-001410	page 59
03-000254	Roof hook set ZD 30 M12	50	5	03-000952	page 58
03-000256	Roof hook set ZD 40 M12	50	5	03-000953	page 58
03-000255	Double roof hook set ZD 30 M12	50	5	03-000936	page 59
03-000222	Stock screw set (for wood) M10 200 mm	50	10	03-001057	page 65
03-000223	Stock screw set (for wood) M10 250 mm	50	10	03-001005	page 65
03-000224	Stock screw set (for wood) M10 300 mm	50	10	03-001006	page 65
03-000211	Stock screw set (for wood) M12 200 mm	50	10	03-001007	page 65
03-000210	Stock screw set (for wood) M12 250 mm	50	10	03-001008	page 65
03-000216	Stock screw set (for wood) M12 300 mm	50	10	03-001009	page 65
03-000199	Stock screw set (for steel) 8,0-M10 140 mm	50	10	03-001023	page 65
03-000202	Stock screw set (for steel) 8,0-M10 185 mm	50	10	03-001013	page 65
03-000203	Stock screw set (for steel) 8,0-M10 220 mm	50	10	03-001014	page 65
03-001069	Rounded seam clamp set M8	50	5	03-001282	page 66
03-001028	Standing seam clamp set 150 M8 IR	50	5	03-001124	page 66
03-000369	Standing seam clamp set M8 for copper	50	5	03-001125	page 66
03-000219	Standing seam clamp set M8	50	5	03-001123	page 66

Alternative packing units

Rail accessories

The following novotegra articles are also available in alternative, smaller packing units (PU):

Art.-Nr.	Bezeichnung	VPE Standard	VPE Alternativ	Art.-Nr.	Produktdetails
03-000259	Slip Guard/ End Cap Set C47	50	10	03-000954	page 74
03-000260	Slip Guard/ End Cap Set C47 black	50	10	03-000955	page 74
03-000261	Slip Guard/ End Cap Set C71	50	10	03-000956	page 74
03-000262	Slip Guard/ End Cap Set C71 black	50	10	03-001089	page 74
03-000263	Slip Guard/ End Cap Set C95	50	10	03-001090	page 74
03-000264	Slip Guard/ End Cap Set C95 black	50	10	03-001091	page 74
03-000372	Module slip guard set box frame	50	10	03-001071	page 73
03-000006	Module slip guard set M6	50	10	03-001070	page 73
03-000007	Module slip guard set M8	50	10	03-001075	page 73
03-001105	Rail connector set C38	50	5	03-001216	page 69
03-000001	Rail connector set C47	50	5	03-001129	page 69
03-000925	Rail connector set C47 S	50	5	03-000972	page 69
03-000151	Rail connector set C71	50	5	03-001131	page 69
03-000130	Rail connector set C95	50	5	03-001133	page 69
03-001106	Expansion joint C38	50	5	03-001217	page 69
03-000138	Expansion joint C47	50	5	03-001130	page 69
03-000265	Expansion joint C71	10	5	03-001132	page 69
03-000173	Expansion joint C95	10	5	03-001134	page 70
03-000226	Cross rail connector set C M14	50	5	03-000961	page 72
03-000370	Base trough connector set 150-30 I	50	5	03-000971	page 108

Tools

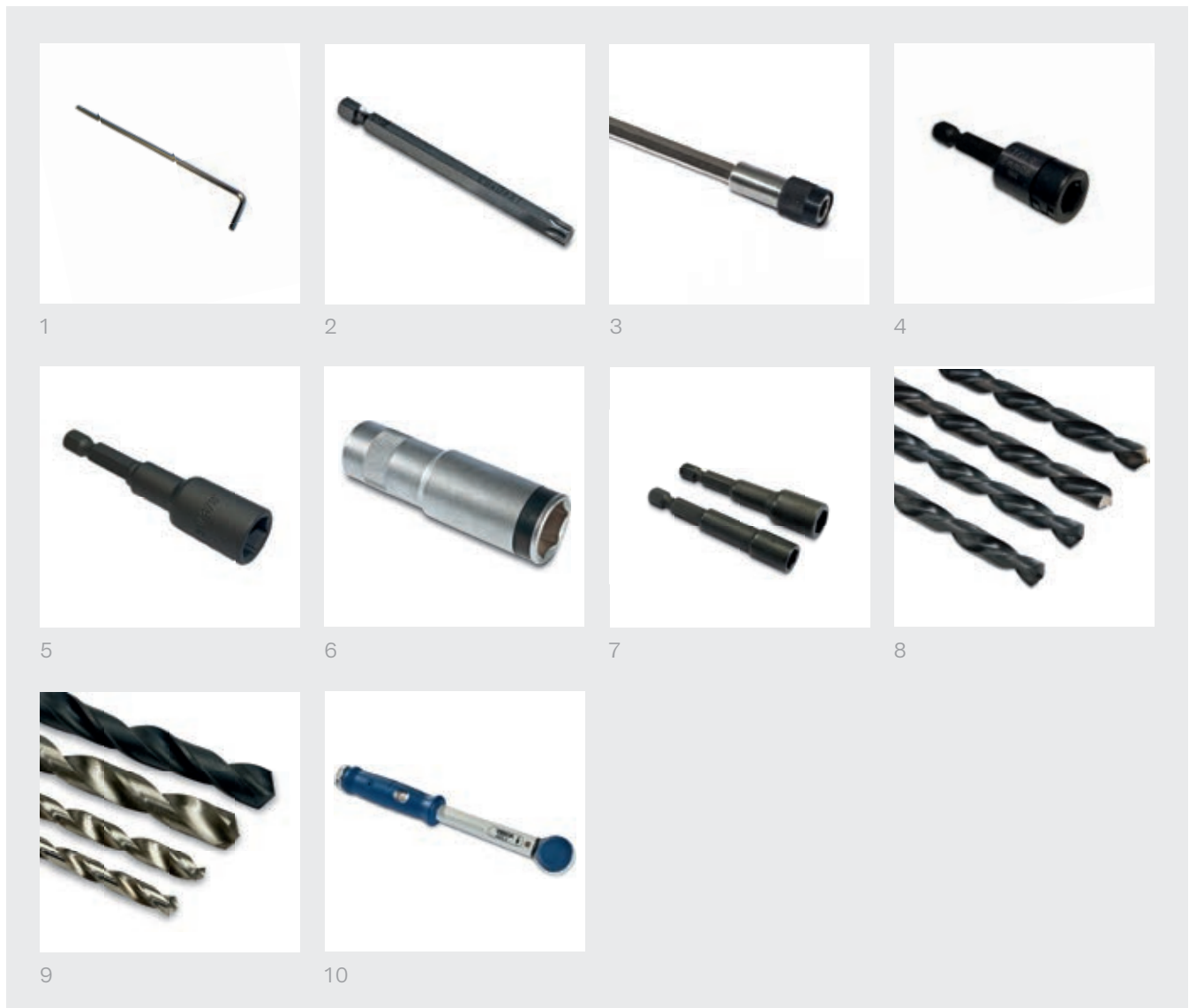

Item no.	Designation	Roof type*	Picture
03-001470	Hexagon key 3 mm	tr, c/s, trapez, sr, facade	1
03-000315	Torx drive TX-25 length = 70 mm	tr	2
03-000104	Torx drive TX-40 length = 70 mm	tr	2
03-000316	Torx drive TX-30 length = 70 mm	tr	2
03-000038	Drive extension 305 mm	tr	3
03-000100	Special nut socket 8 mm	for all roofs	4
03-001471	Special nut socket 13	tr, c/s, trapez, sr	5
03-000011	special long nut socket 18 mm	tr, c/s, trapez, sr, fr I	6
03-000966	Threaded socket driver f. stock screw M10	c/s	7
03-000930	Threaded socket driver f. stock screw M12	c/s	7
03-000114	Drill bit 6.8 mm length 230 mm	c/s	8
03-000115	Drill bit 7,0mm length 230 mm	c/s	8
03-000116	Drill bit 7,2mm length 230 mm	c/s	8
03-000117	Drill bit 7,4mm length 230 mm	c/s	8
03-000245	Drill bit 7,5mm length 225 mm	c/s	9
03-000108	Drill bit 9,0mm length 230 mm	c/s	9
03-000246	Drill bit 14 mm HSS short	c/s	9
03-000107	Drill bit 16 mm HSS short	c/s	9
03-000036	Torque wrench 1/4", 4-20 Nm	tr, c/s, trapez, sr, fr I + II	10

Tools



Item no.	Designation	Roof type*	Picture
03-00037	Torque wrench 1/2", 20-100 Nm	tr, c/s, trapez, sr, fr I	11
03-000602	Adapter 1/4" hexagonal to 1/2" square	tr, c/s, trapez, sr, fr I	12
03-000604	Bit for triple-square screws, size AW 25		13
03-000603	Bit for triple-square screws, size AW 30		13
03-000605	Bit for triple-square screws, size AW 40		13
03-000576	Assembling jig 800-1200 mm, C-shaped	tr, c/s, trapez, sr, fr I + II	14
03-000574	Assembling jig 1300-1700 mm, C-shaped	tr, c/s, trapez, sr, fr I + II	14
03-000577	Assembling jig 800-1200 mm, C-shaped	tr, c/s, trapez, sr, fr I + II	14
03-000575	Assembling jig 1300-1700 mm, C-shaped	tr, c/s, trapez, sr, fr I + II	14
03-000579	Assembling jig set 800-1200 mm, 2-piece	tr, c/s, trapez, sr, fr I + II	14
03-000578	Assembling jig set 1300-1700 mm 2-piece	tr, c/s, trapez, sr, fr I + II	14
03-000462	Mounting tool trapezoidal sheet bracket IR	trapez	15
03-000464	Mounting tool trapezoidal sheet bracket IR FL	trapez	15
03-000463	Mounting tool trapezoidal sheet bracket elevation profile pair	trapez	15
03-001323	Removal tool roof hook ZD 30 N35	tr	16

* type of roof:

tr = tile roof

c/s = corrugated and sandwich roof

trapez = trapezoidal roof

sr = seamed roof

fr = flat roof



3

Flat roof

Mounting system flat roof I (cross layer system)

	 flat roof foil- / bitumen	 flat roof gravel			
base trough	 base trough with protection layer	 base trough for cross drainage	 onto gravel	 with gravel as ballast	
elevation	<div style="text-align: center;">   </div> <div style="text-align: center;"> east-west-system </div>  module support set east-west 150	 module bracket set back east-west	<div style="text-align: center;">   </div> <div style="text-align: center;"> south-system </div>  module support set south	 wind deflector	
module attachment	<div style="text-align: center;">  </div>  base profile	 module bracket front (connect to the module frame holes)	 module bracket front (connect to the module frame)		

Mounting system flat roof II (single layer system)

 <p>flat roof foil-/ bitumen</p>	 <p>flat roof gravel</p>	<p>base trough</p>	
 <p>base trough with protection layer</p>  <p>base trough for cross drainage</p>	 <p>onto gravel</p>		
<p>East-West-system</p>		<p>South-system</p>	<p>elevation</p>
 <p>module support set east-west II single</p>  <p>module support set east-west II double</p>	 <p>module support closed II</p>  <p>wind deflector</p>		
 <p>mid clamp (short side)</p>  <p>end clamp (long side)</p>  <p>end clamp (short side)</p>			<p>module attachment</p>

Flat roof | east-west system II

Flat roof system east-west II on foil

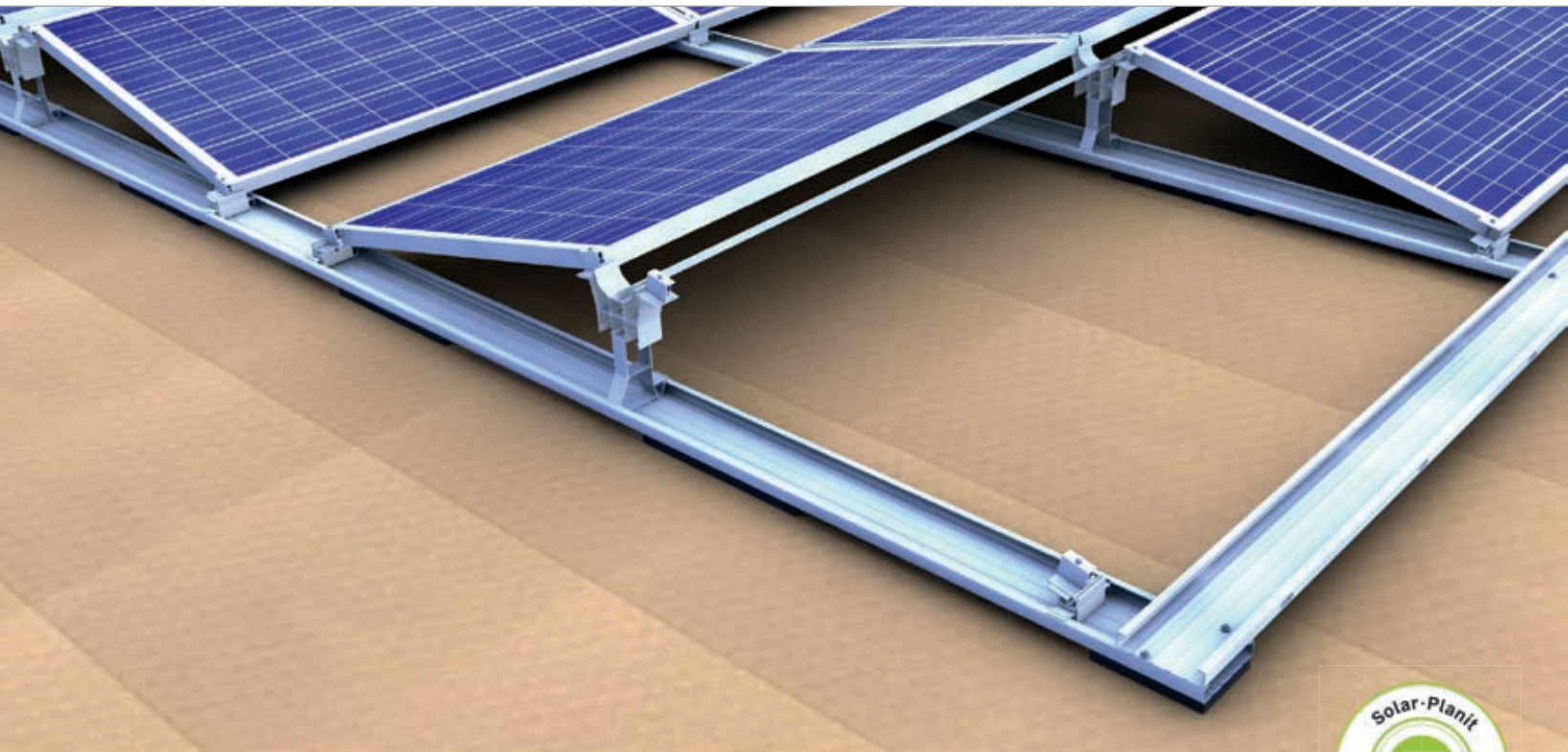
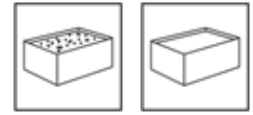

Our solution for east-west direction

- aximum roof surface utilisation and evenly distributed electricity production
- optimum elevation angle 13° for good efficieny and self-cleaning
- cross connections at module field edges for high stability
- high flexibility thanks to individually selectable row distance
- connected module fields up 34 m length possible

Produktvarianten

- different base troughs: blank, with PE separation layer or with PE pads for cross drainage
- clamps for long frame side, e.g. third base trough for extreme snow and wind loads
- double support for heavy loads

Your benefits

- wind-tunnel tested aerodynamics
- wide and continuous base troughs for optimum load redistribution and low surface pressure
- module supports and base feet with click-fit function – no screwing necessary
- suitable for wide modules

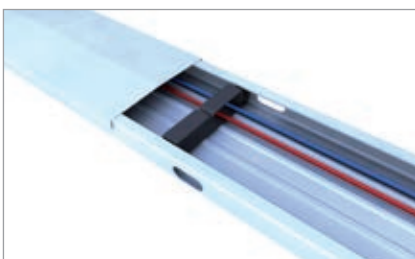

Base trough with cover and cable bracket

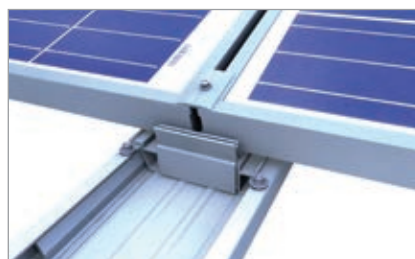

Base foot in base trough with connector



Wind deflector East-West for roof obstacles with module support double

Flat roof system | east-west system II

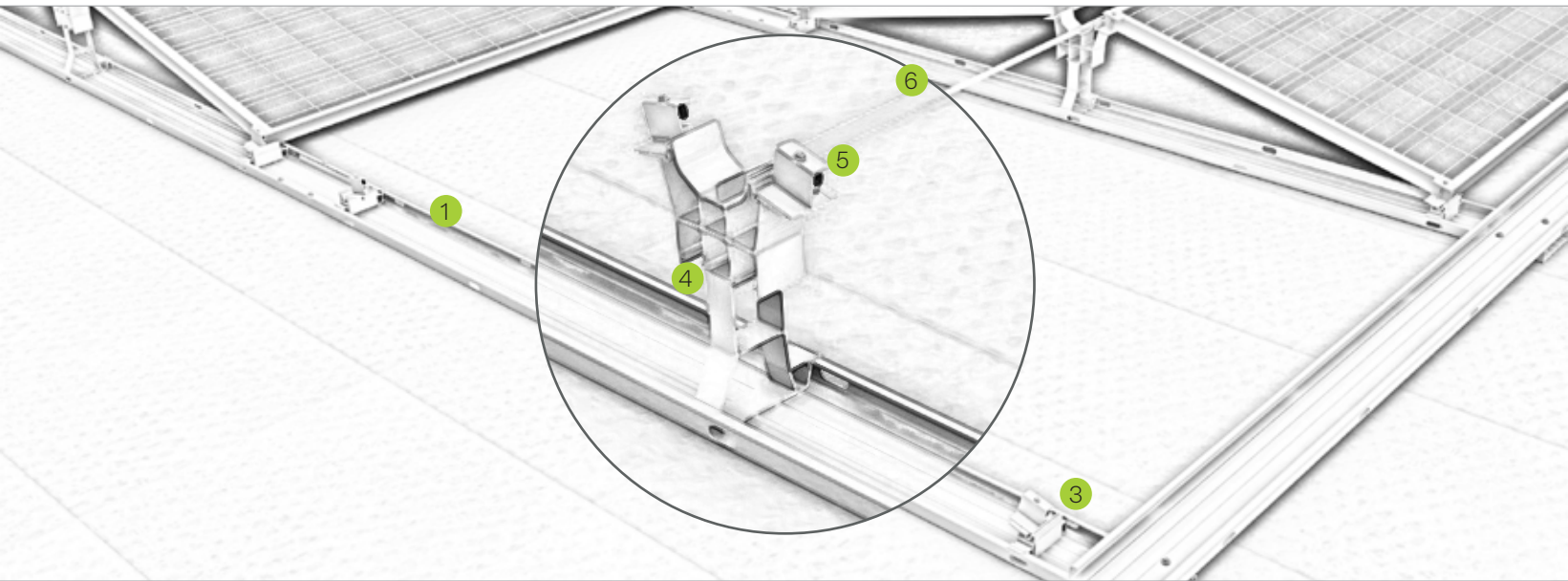

Pic Designation

- | | |
|---|---|
| ① | Base trough <ul style="list-style-type: none"> ▪ much space for ballast, optionally ballast trough available ▪ top cover when used as a cable channel |
| ② | Connectors and expansion joints <ul style="list-style-type: none"> ▪ connectors for module fields up to 17 m length ▪ expansion joints to connect two 17 m module fields |
| ③ | Base foot <ul style="list-style-type: none"> ▪ quick click-fit without additional screwing ▪ predrilled mounting hole for easy positioning |
| ④ | Module support <ul style="list-style-type: none"> ▪ quick click-fit without additional screwing ▪ predrilled mounting hole for easy positioning |
| ⑤ | Module bracket <ul style="list-style-type: none"> ▪ entirely pre-assembled ▪ screw with drill bit for easy assembly |
| ⑥ | Load redistribution via support brace <ul style="list-style-type: none"> ▪ for cross connection and load redistribution ▪ Material optimised and effective |

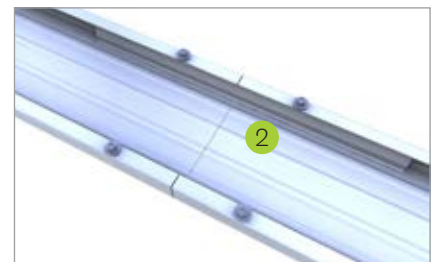

Base trough extension

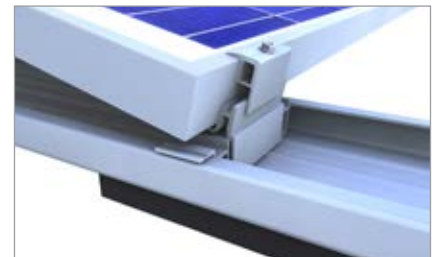

Base foot in base trough with pads

Flat roof | south system II

Flat roof system closed II

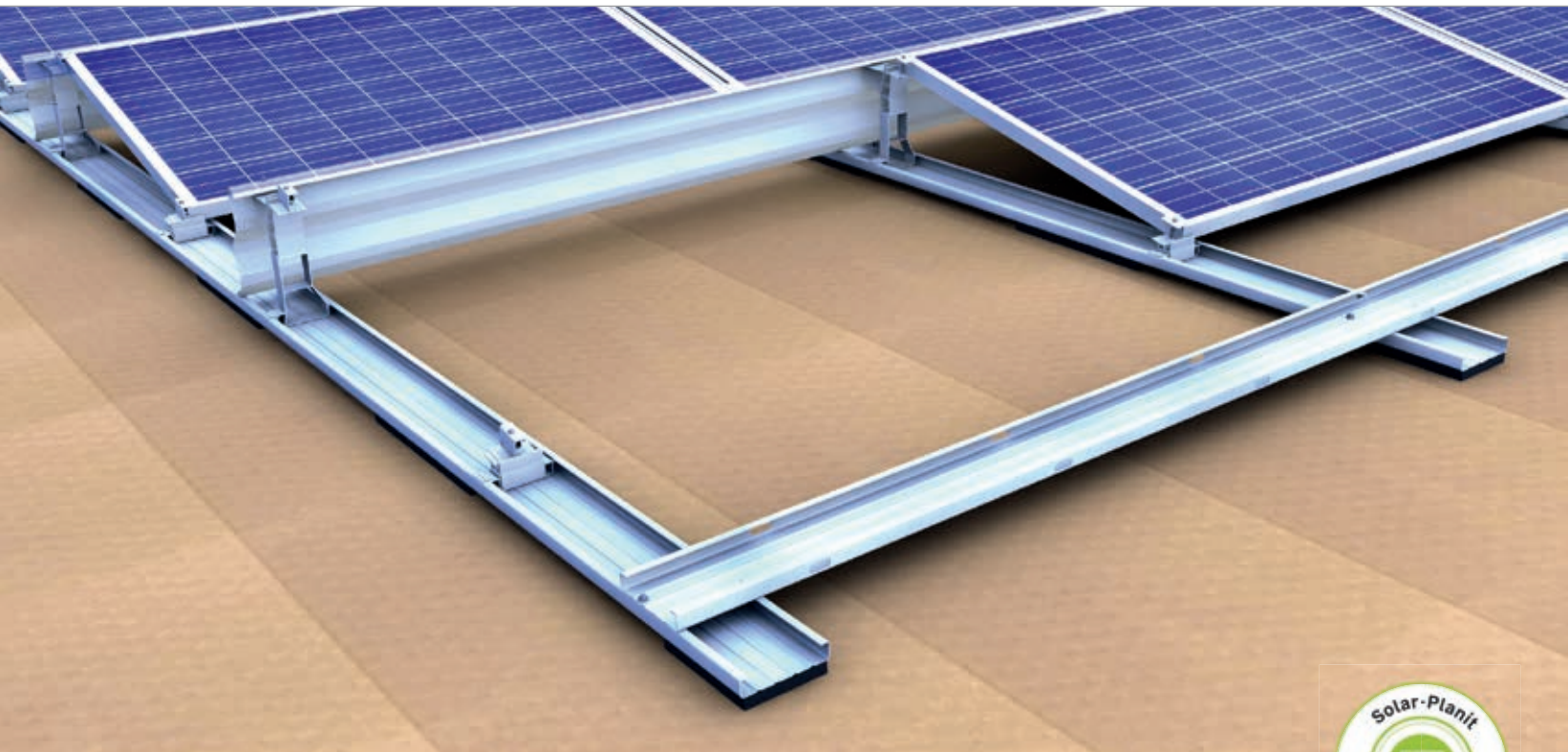
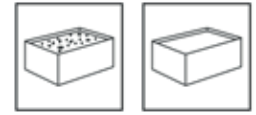

Our solution for south-facing direction

- optimum module orientation towards south
- optimum elevation angle 13° for good efficiency and self-cleaning
- cross connections at module field edges for high stability
- high flexibility thanks to individually selectable row distance
- connected module fields up 34m length possible

product variants

- different base troughs: blank, with PE separation layer or with PE pads for cross drainage
- clamps for long frame side, e.g. third base trough for extreme snow and wind loads
- wind deflectors for 72-cell modules (up to 2,18m length)

Your benefits

- wind-tunnel tested aerodynamics
- wide and continuous base troughs for optimum load redistribution and low surface pressure
- module supports and base feet with click-fit function – no screwing necessary
- suitable for wide modules

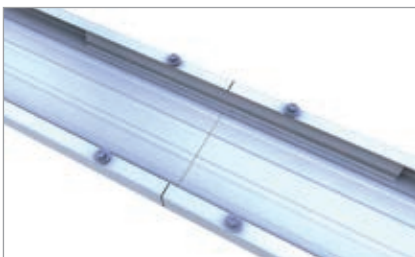

Base trough extension

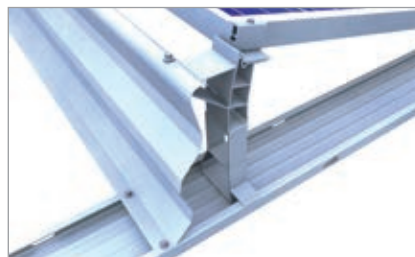

Wind deflector and module support

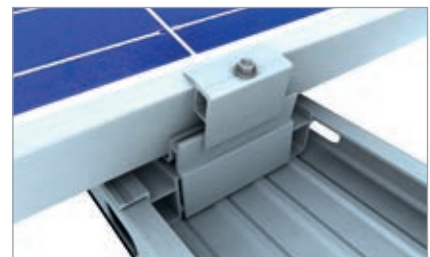

Module clamp long frame side for third base trough

Flat roof system | south system II

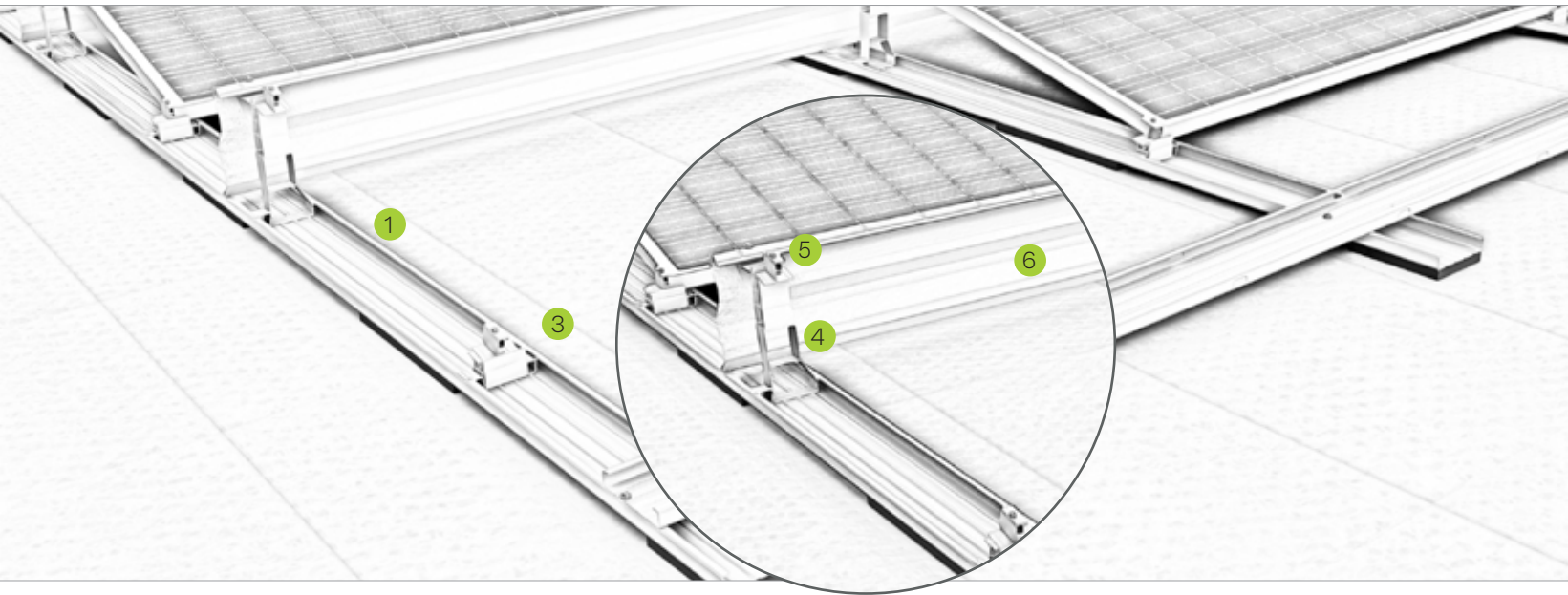

Pic Designation

- | | |
|---|---|
| 1 | Base trough <ul style="list-style-type: none"> ▪ much space for ballast, optionally Ballast trough available ▪ top cover when used as a cable channel |
| 2 | Connectors and expansion joints <ul style="list-style-type: none"> ▪ connectors for module fields up to 17 m length ▪ expansion joints to connect two 17 m module fields |
| 3 | Base foot <ul style="list-style-type: none"> ▪ quick click-fit without additional screwing ▪ predrilled mounting hole for easy positioning |
| 4 | Module support <ul style="list-style-type: none"> ▪ quick click-fit without additional screwing ▪ predrilled mounting hole for easy positioning |
| 5 | Module bracket <ul style="list-style-type: none"> ▪ entirely pre-assembled ▪ screw with drill bit for easy assembly |
| 6 | Load redistribution via wind deflector <ul style="list-style-type: none"> ▪ for cross connection and load redistribution ▪ aerodynamic design und easy installation |

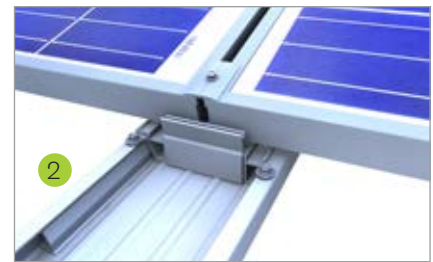

Base foot in base trough with connector

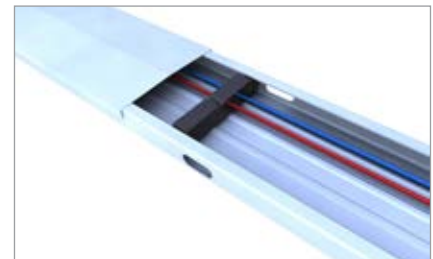

Base trough with cover and cable bracket

Flat roof | east-west system I

Flat roof system east-west I for gravel

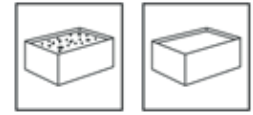

Our flexible solution for east-west-facing direction

- maximum roof surface utilisation and evenly distributed electricity production
- optimum elevation angle 13° for good efficiency and self-cleaning
- cross connections at module field edges for high stability
- high flexibility thanks to individually selectable row distance
- connected module fields up 34 m length possible

product variants

- different base troughs: blank, with PE separation layer or with PE pads for cross drainage
- gravel base trough 230-90 for convenient ballasting with existing gravel

Your benefits

- wind-tunnel tested aerodynamics
- wide and continuous base troughs for optimum load redistribution and low surface pressure
- stability and flexibility thanks to cross layer system and module clamping in the optimum clamping range
- suitable for wide modules



Module support and C-rail



Base profile fastening to base trough



Module bracket set front

Flat roof system | east-west system

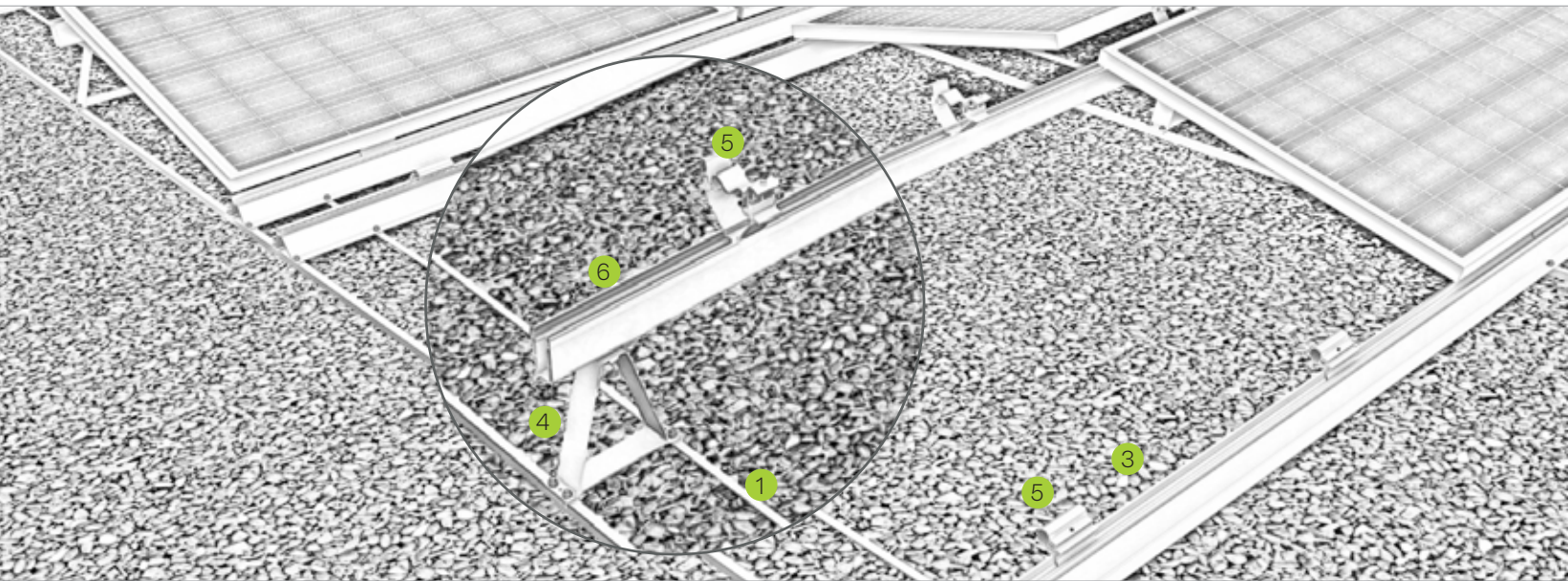

Pic Designation

- | | |
|---|---|
| ① | Base trough <ul style="list-style-type: none"> ▪ much space for ballast, optionally Ballast trough available ▪ no penetration of the roof membrane |
| ② | Connectors and expansion joints <ul style="list-style-type: none"> ▪ connectors for module fields up to 17 m length ▪ expansion joints to connect two 17 m module fields |
| ③ | Base profile <ul style="list-style-type: none"> ▪ module support and load redistribution at the same time ▪ serves to hold the front module fastener |
| ④ | Module support <ul style="list-style-type: none"> ▪ for placement and fixing of the C-rail ▪ for mounting on the gravel rail |
| ⑤ | Module bracket <ul style="list-style-type: none"> ▪ entirely pre-assembled ▪ for connection via the existing module frame hole |
| ⑥ | Load redistribution via C-rail 71 <ul style="list-style-type: none"> ▪ for cross connection and load redistribution ▪ top cover when used as a cable channel |

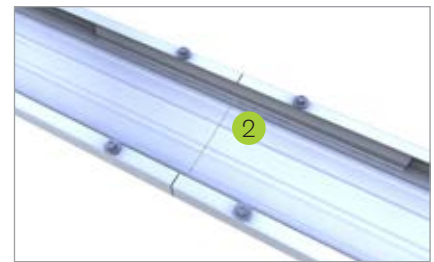

Base trough extension



C-rail as cable channel

Flat roof | south system I

Flat roof system closed I

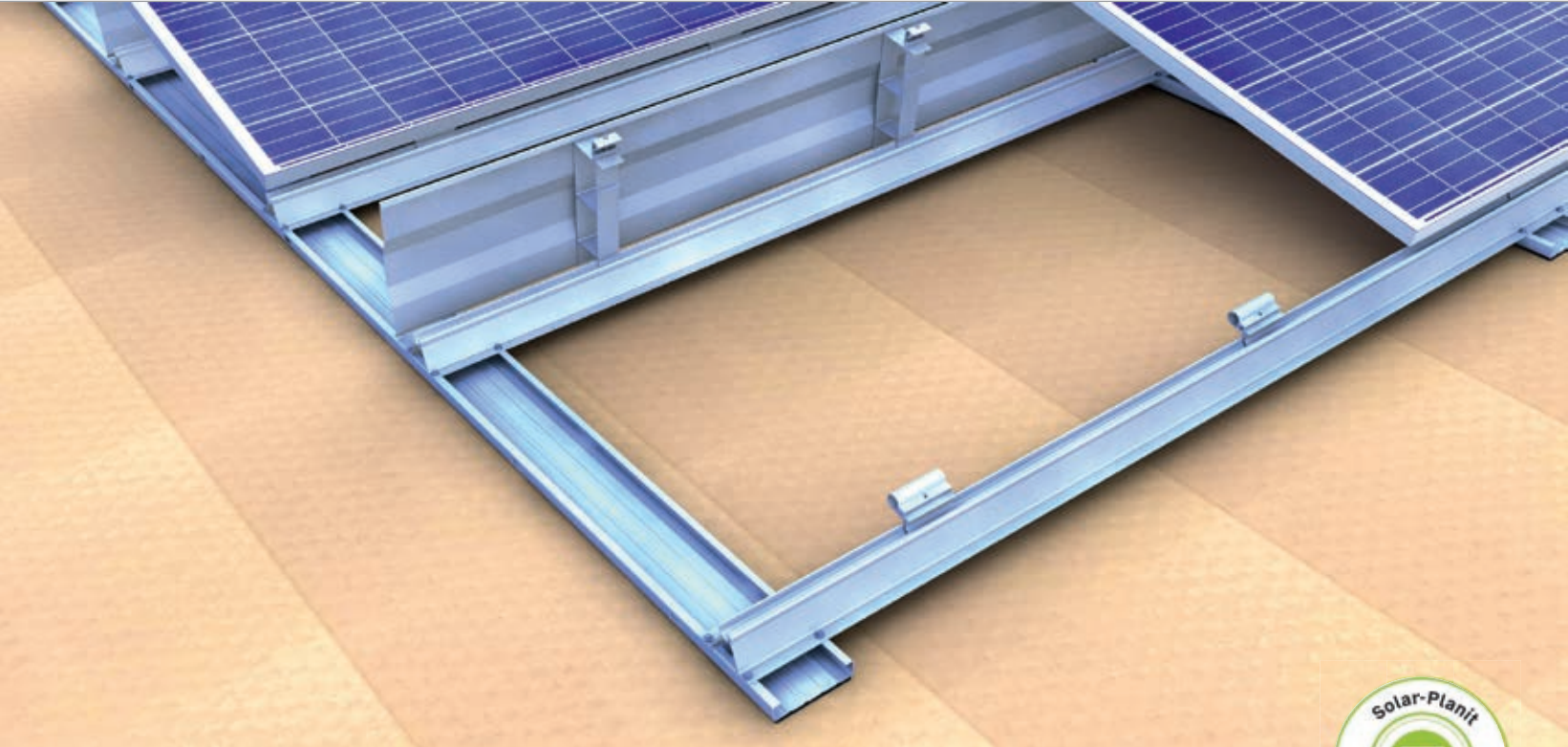
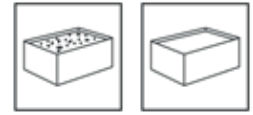

Our flexible solution for south-facing direction

- optimum module orientation towards south
- optimum elevation angle 13° for good efficiency and self-cleaning
- cross connections at module field edges for high stability
- high flexibility thanks to individually selectable row distance
- connected module fields up to 34 m length possible

product variants

- different base troughs: blank, with PE separation layer or with PE pads for cross drainage
- gravel base trough 230-90 for convenient ballasting with existing gravel
- Wind deflector for 72-cell modules (up to 2,18m length)

Your benefits

- wind-tunnel tested aerodynamics
- wide and continuous base troughs for optimum load redistribution and low surface pressure
- stability and flexibility thanks to cross layer system and module clamping in the optimum clamping range
- suitable for wide modules

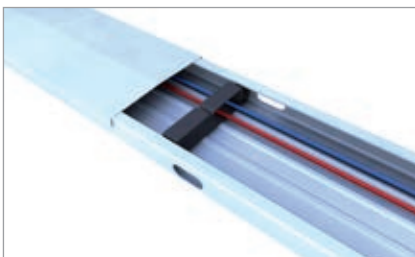

Base trough with cover and cable bracket



Module support and wind deflector closed I



Module bracket set front in base profile

Flat roof system | south system I

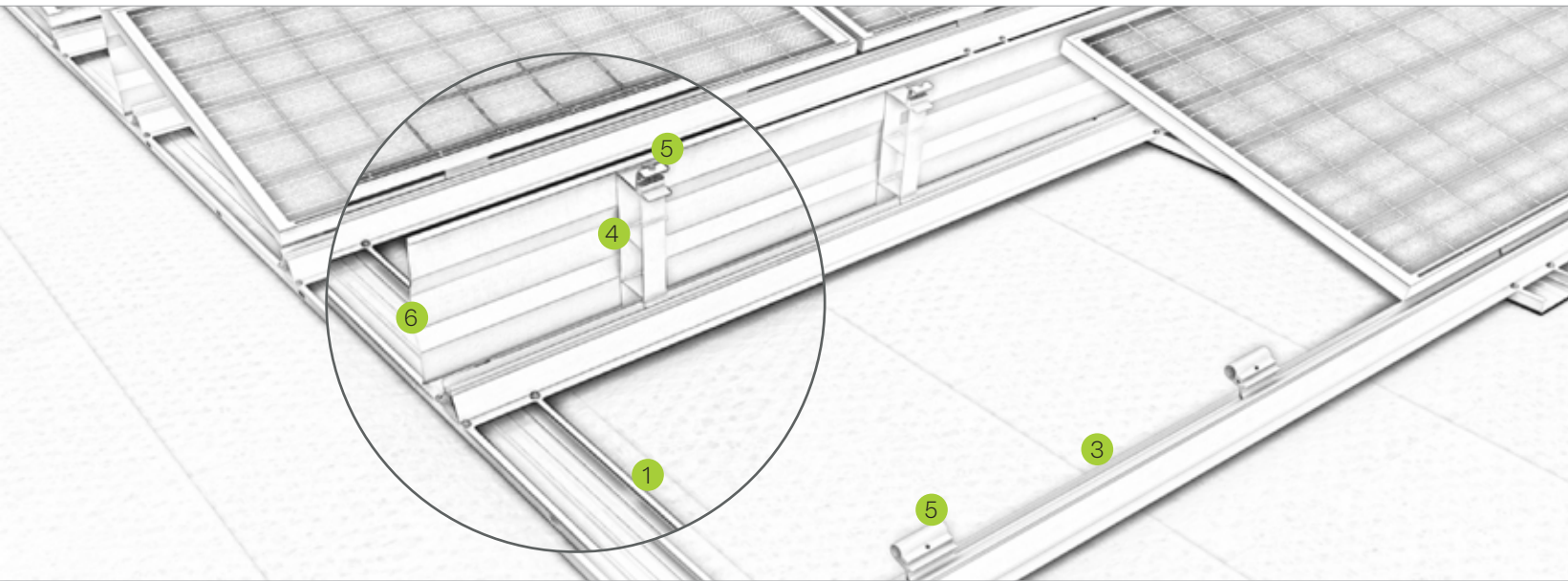

Pic Designation

- | | |
|---|---|
| ① | Base trough <ul style="list-style-type: none"> ▪ much space for ballast, optionally ballast trough available ▪ top cover when used as a cable channel |
| ② | Connectors and expansion joints <ul style="list-style-type: none"> ▪ connectors for module fields up to 17 m length ▪ expansion joints to connect two 17 m module fields |
| ③ | Base profile <ul style="list-style-type: none"> ▪ module support and load redistribution at the same time ▪ serves to hold the front module fastener |
| ④ | Module support <ul style="list-style-type: none"> ▪ for placement and fixing of the C-rail ▪ for mounting on the gravel rail |
| ⑤ | Module bracket <ul style="list-style-type: none"> ▪ entirely pre-assembled ▪ for connection via the existing module frame hole |
| ⑥ | Load redistribution via wind deflector <ul style="list-style-type: none"> ▪ for cross connection and load redistribution ▪ aerodynamic design and easy installation |

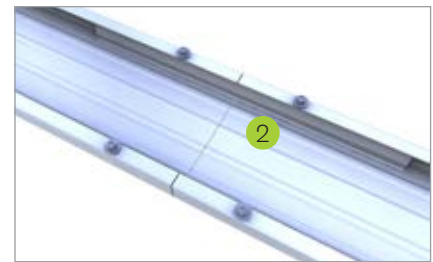

Base trough extension



Flat roof system closed I on gravel

Green roof | East-west system

Clamping system with modules installed in portrait

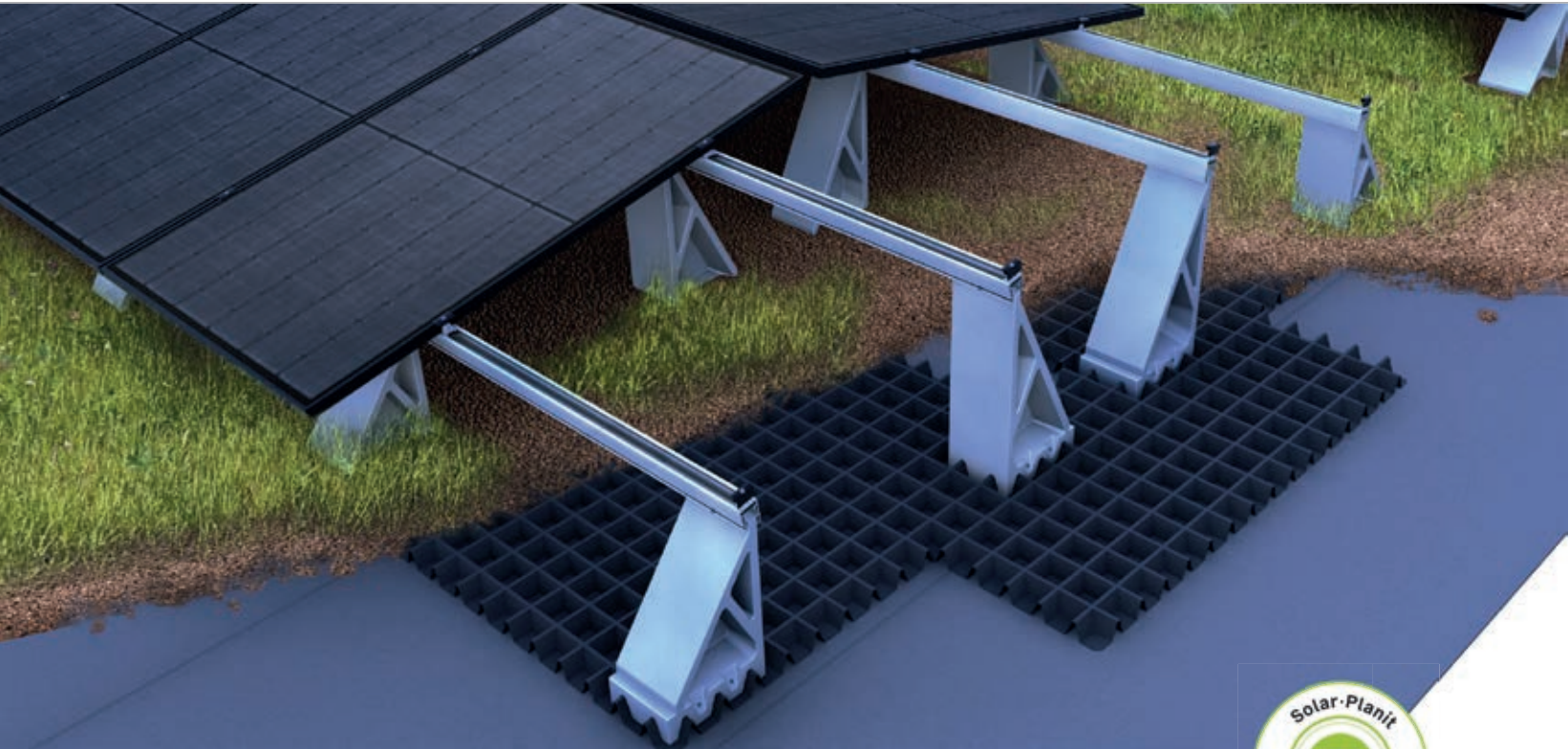

Biotope, water storage, air conditioning – the all-in-one package for your roof!

- Suitable for a wide range of green roofs
- Retention effect: Time-delayed water run-off relieves the sewage system – especially during heavy rainfall
- Natural cooling of the ambient temperature and the PV system
- Sustainable production made in Germany from recycled plastic

Product variants

- Different layouts possible with the same components: east-west, butterfly, south-facing
- Only two clamps for all frame heights in blank and black anodized
- Many optional components for the perfect system: top cover C-rail, grounding connector, contact latch, optimiser fastening, etc.

YOUR BENEFITS

- Efficient use of space thanks to 10° module inclination and portrait installation
- Large substrate plates to offer sufficient space for ballasting
- Wind-tunnel-tested aerodynamics
- Sufficient distance from the roof surface for plant growth and sliding snow
- Interconnected panels for quick and easy assembly

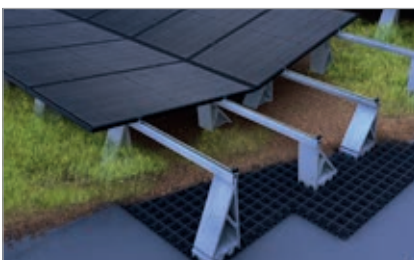

Butterfly variant

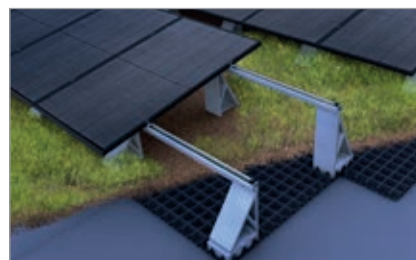

South-facing variant

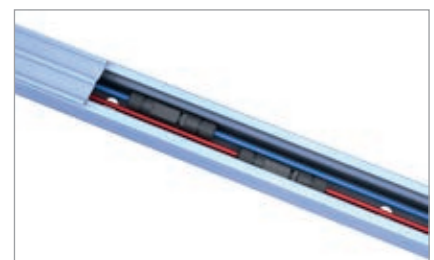

Module support rail also acts as a cable channel

Green Roof | East-west system

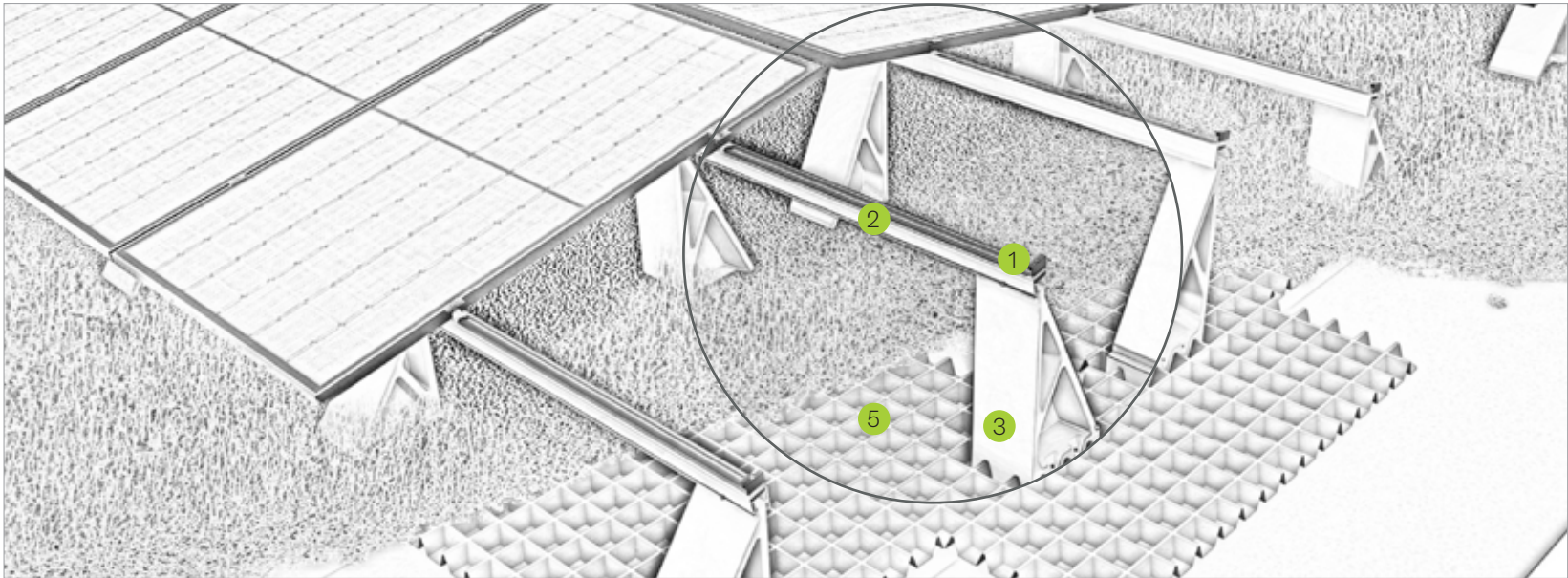

Pic Designation

- | | |
|---|--|
| ① | Middle and end clamp <ul style="list-style-type: none"> ▪ for frame heights of 30-42 mm and 43-52 mm ▪ installation-friendly thanks to click-in mechanism |
| ② | Module support rail <ul style="list-style-type: none"> ▪ Also acts as a cable channel ▪ Internal rail connector for maximum mounting freedom |
| ③ | Module support <ul style="list-style-type: none"> ▪ Simple and flexible positioning ▪ Positive fit with the substrate plate for excellent stability |
| ④ | Mounting screw <ul style="list-style-type: none"> ▪ Fast and secure connection of the green roof components |
| ⑤ | Substrate plate <ul style="list-style-type: none"> ▪ Plenty of substrate space for ballasting ▪ Water storage volume supports the retention effect |

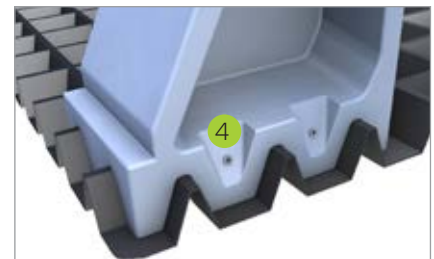

Positive fit of substrate plate and support

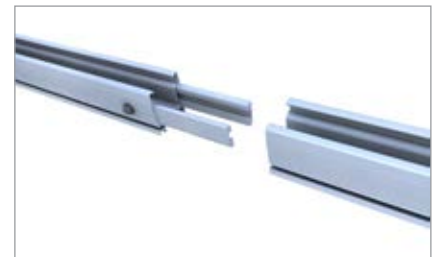

Internal rail connector



novotegra for flat roof –
the perfect solution for
every project size



Mounting solutions for flat roof

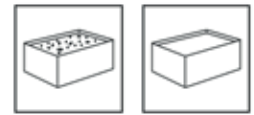

Foil roof: east-west system II with third base trough



On gravel: east-west system I with north-south orientation on gravel



On gravel: east-west system II

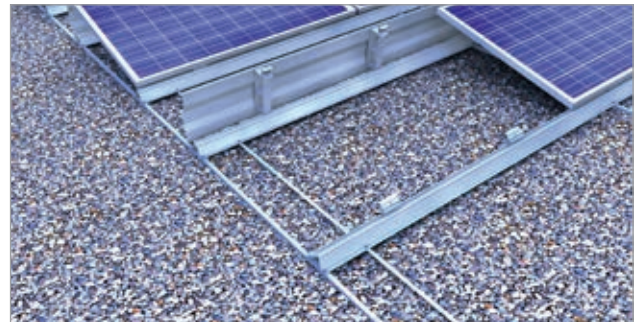

On gravel: south system I with gravel as ballast



Foil roof: south system closed II with third base trough



Foil roof: east-west system I with north-south orientation

Your benefits

- aerodynamic system tested in a wind tunnel – reliable security
- only a handful of components which are quickly and easily assembled – a flexible system
- wide and continuous base troughs for optimum load redistribution and low surface pressure
- alternative solutions with stable cross layer systems and elevation triangles



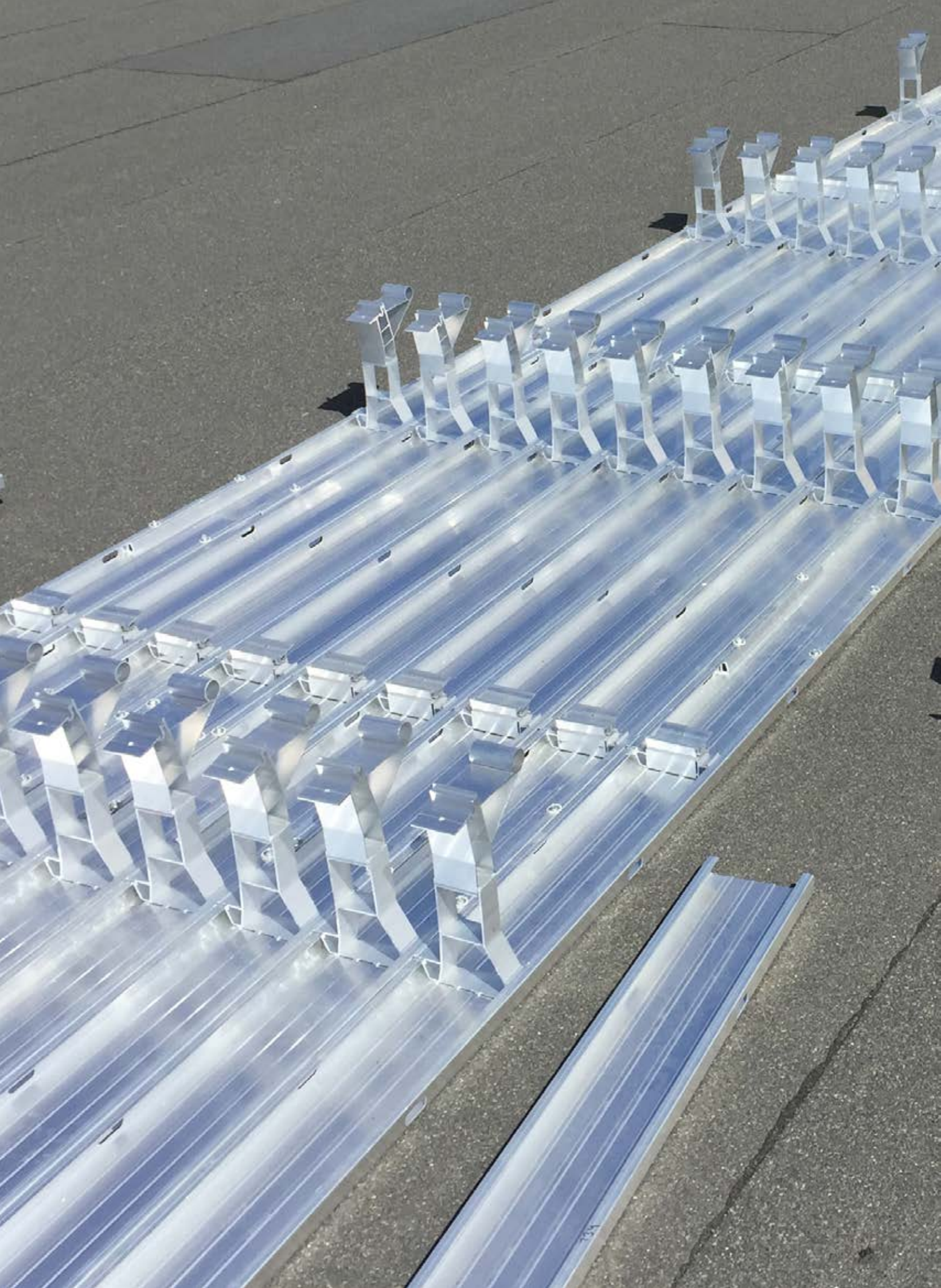

4

Single items
flat roof

Profile rails

Base troughs flat roof - without protection layer

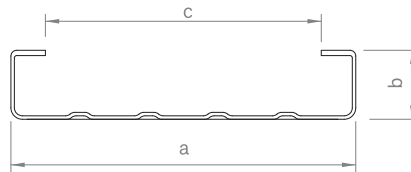

Base trough for flat roof elevations for click-fit of the base feet and module supports (flat roof system II) or for fixing the base profile (flat roof system I) and inserting the ballast.

Item no.	Designation	a in mm	b in mm	c in mm	Material
03-001407	Base trough 150-30 2.20m	150	30	120	Alu
03-000087	Base trough 150-30 6.00m	150	30	120	Alu

Base troughs flat roof - with protection layer

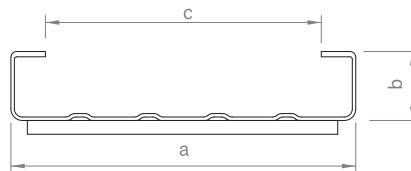

Base trough for flat roof elevations for click-fit of the base feet and module supports (flat roof system II) or for fixing the base profile (flat roof system I) and inserting the ballast. Constructed as a base with a pre-assembled 6 mm separation layer.

Item no.	Designation	a in mm	b in mm	c in mm	Material
03-001408	Base trough 150-30 w/protection layer 2.20m	150	30	120	Alu / PE
03-000989	Base trough 150-30 w/protection layer 6.00m	150	30	120	Alu / PE

Base troughs cross drainage flat roof

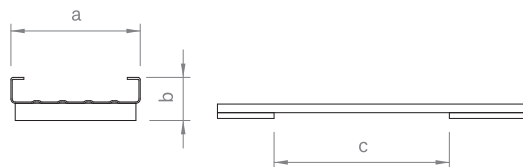

Base trough for flat roof elevations for click-fit of the base feet and module supports (flat roof system II) or for fixing the base profile (flat roof system I) and inserting the ballast. Pre-assembled with PE pads, grid 610 mm, as separation or drainage layer when placed transversely to the roof pitch.

Item no.	Designation	a in mm	b in mm	c in mm	Material
03-001409	Base trough 150-30 w/cross drainage 2.20 m	150	50	610	Alu / PE
03-000879	Base trough 150-30 w/cross drainage 6.00 m	150	50	610	Alu / PE

Top cover base trough

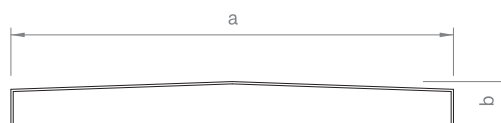

Cover for the base trough if using as cable channel.

Item no.	Designation	a in mm	b in mm	c in mm	Material
03-000133	Top cover base trough 150-30 3.00 m	154	15		Alu

Profile rails

Support brace east-west II

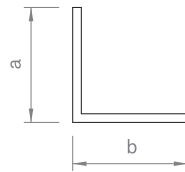

Support brace for load transfer, fixed on the flat roof module support sets east-west II.

Item no.	Designation	a in mm	b in mm	c in mm	Material
03-001474	Support brace 20 × 20 × 1.5 5.40 m	20	20		Alu
03-001443	Support brace 20 × 20 × 1.5 4.45 m	20	20		Alu
03-001474	Support brace 20 × 20 × 1.5 1.85 m	20	20		Alu

Ballast troughs base trough

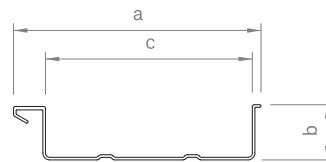
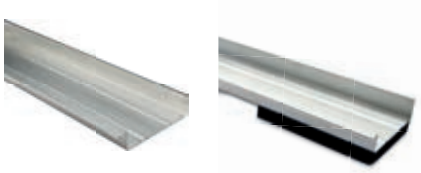

Ballast trough to clip into the base trough and secure placement of large format ballast. Constructed as a ballast trough without or with a pre-assembled separation layer.

Item no.	Designation	a in mm	b in mm	c in mm	Material
03-000131	Ballast trough 120-30 530 mm	144	32	120	Alu
03-000977	Ballast trough 530 mm w/protection layer	144	32	120	Alu/PE
03-000910	Ballast trough w/cross drainage 530 mm	144	32	120	Alu/PE

Gravel base trough

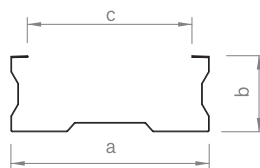
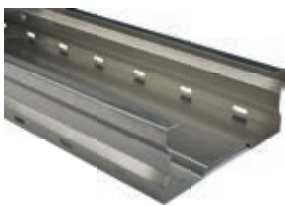

Base trough for flat roof elevations to fix the base profiles and for ballasting with existing gravel (flat roof I).

Item no.	Designation	a in mm	b in mm	c in mm	Material
03-000092	Base trough 230-90 6.00 m	230	90	190	Alu

Base profile elevation

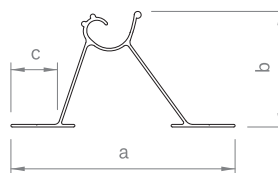

Module support rail for module elevation on flat roofs (flat roof I) as well as for trapezoidal sheet, corrugated and sandwich roofs.

Item no.	Designation	a in mm	b in mm	c in mm	Material
03-000193	Base profile 6.12 m	130	67	27	Alu
03-000194	Base profile 5.06 m	130	67	27	Alu
03-000195	Base profile 3.37 m	130	67	27	Alu

Rails connectors

Base trough connector 150-30 I

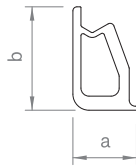

Connector Base trough 150-30, l = 380 mm. Alternative packing units see p. 87.

Item no.	Designation	a in mm	b in mm	c in mm	Material
03-000370	Base trough connector set 150-30 I	16	26		Alu

Base trough expansion joint

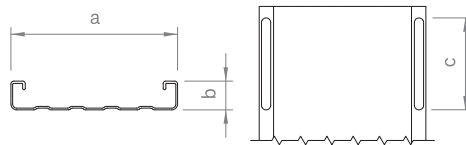

Base trough expansion joint 150-30, l = 380 mm, single-sided with slots.

Item no.	Designation	a in mm	b in mm	c in mm	Material
03-000128	Base trough expansion joint 150-30	150	25	80	Alu

Angled base trough connector 150-30

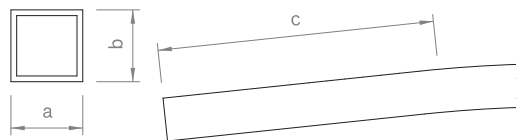

Connector base trough, l = 380 mm, for ridge and throat formation 2° – 5°.

Item no.	Designation	a in mm	b in mm	c in mm	Material
03-000161	Angled base trough connector 150-30 3°	25	25	180	Alu

Coupling profile

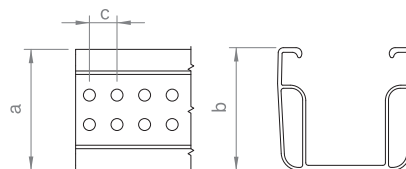

Coupling profile for reducing the ballast of adjacent module fields with expansion gaps in between on flat roof elevations through coupling of the bordering base troughs (flat roof II).

Item no.	Designation	a in mm	b in mm	c in mm	Material
03-000929	Coupling profile C47 385 mm	52	47	12	Alu

Rails connectors

Base profile connector

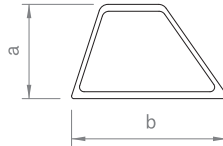

Connector base profile, l = 380 mm.

Item no.	Designation	a in mm	b in mm	c in mm	Material
03-00021	Base profile connector	41	68		Alu

Base profile expansion joint

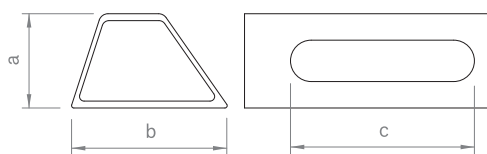

Expansion joint construction single-sided with slots, l = 380 mm

Item no.	Designation	a in mm	b in mm	c in mm	Material
03-000129	Base profile expansion joint	41	68	80	Alu

Angled base profile connector (rise)

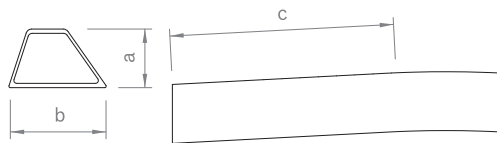

Connector base profile, l = 380 mm, for ridge formation 2° – 5°.

Item no.	Designation	a in mm	b in mm	c in mm	Material
03-000162	Angled base profile connector 3° (rise)	41	68	150	Alu

Angled base profile connector (dip)

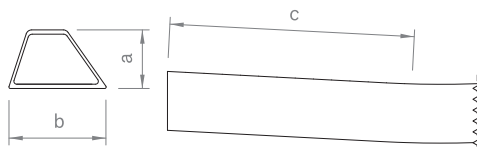

Connector base profile, l = 380 mm, for throat formation 2° – 5°.

Item no.	Designation	a in mm	b in mm	c in mm	Material
03-000163	Angled base profile connector 3° (dip)	41	68	150	Alu

Module elevation and module attachment

Base foot

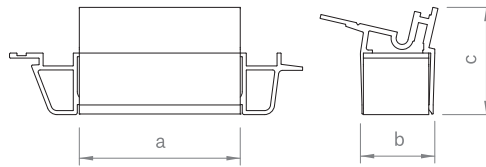

Front module support of the flat roof system generation II, to clip into the base trough.

Item no.	Designation	a in mm	b in mm	c in mm	Material
03-000343	Base foot set 13° 150-30	80	37	53	Alu

Module support east-west II

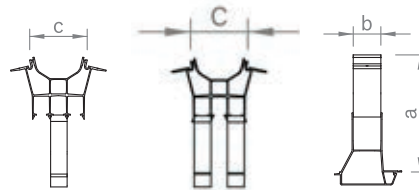

Rear module support for flat roof system east-west II, to clip into the base trough and to connect the support brace, constructed as a one-hip or two-hip support.

Item no.	Designation	a in mm	b in mm	c in mm	Material
03-001324	Module support set 13° 150-30 e/w single	255	60	125	Alu
03-001325	Module support set 13° 150-30 e/w double	255	60	125	Alu

Wind deflector east-west II

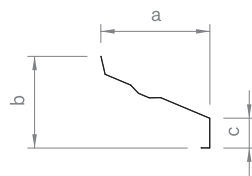

Wind deflector for flat roof system east-west II for mounting areas with missing module due to obstacles..

Item no.	Designation	a in mm	b in mm	c in mm	Material
03-001465	Wind deflector 13° 2.35 m e/w	241	175	65	Alu

Module support closed II

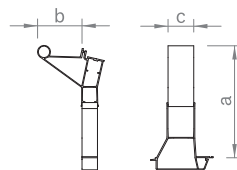

Rear module support of the closed flat roof system II, to clip into the base trough and to fix the wind deflector 13° on it.

Item no.	Designation	a in mm	b in mm	c in mm	Material
03-001243	Module support set 13° 150-30	260	104	60	Alu

Module elevation and module attachment

Wind deflector closed II

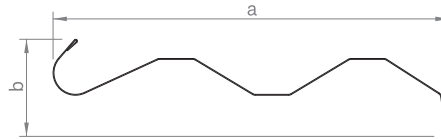
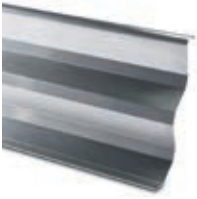

Wind deflector for flat roof system closed II for wind deflection and ballast reduction.

Item no.	Designation	a in mm	b in mm	c in mm	Material
03-001281	Wind deflector 13° 1.95 m	270	70		Alu
03-001439	Wind deflector 13° 2.35 m	270	70		Alu

Flat roof mid clamp (short side)

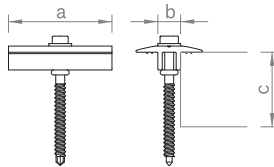

Middle clamp for flat roof system generation II, for fixing modules on the short side of the frame. Clamping screw with 8 AF hexagon drive, for frame heights of 28 – 42 mm or 43 – 52 mm, completely pre-assembled.

Item no.	Designation	a in mm	b in mm	c in mm	Material
03-000324	Flat roof mid clamp 30-42	52	11,4	28–42	Alu / A2SS
03-000323	Flat roof mid clamp 43-52	52	11,4	43–52	Alu / A2SS

Flat roof end clamp (short side)

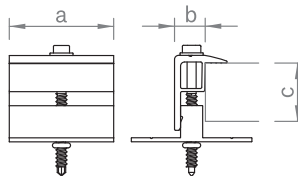

End clamp with T-adaptor for flat roof system generation II, for fixing modules on the short side of the frame. Clamping screw with 8 AF hexagon drive, for frame heights of 28 – 33 mm, 34 – 42 mm or 43 – 52 mm, completely pre-assembled.

Item no.	Designation	a in mm	b in mm	c in mm	Material
03-000309	Flat roof end clamp (short side) 30-42	52	14	34–42	Alu / A2SS
03-000311	Flat roof end clamp (short side) 43-52	52	14	43–52	Alu / A2SS

Flat roof end clamp (long side)

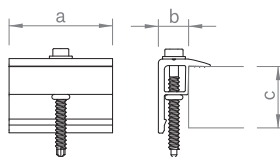

End clamp for flat roof system generation II, for fixing modules on the long side of the frame for example in the case of a third base trough. Clamping screw with 8 AF hexagon drive, for frame heights of 28 – 33 mm, 34 – 42 mm or 43 – 52 mm, completely pre-assembled.

Item no.	Designation	a in mm	b in mm	c in mm	Material
03-000396	Flat roof end clamp 30–42	52	14	34–42	Alu / V2A
03-000397	Flat roof end clamp 43–52	52	14	43–52	Alu / V2A

Module elevation and module attachment

Module support east-west I

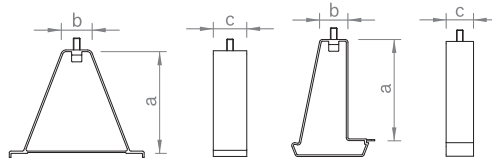

Module support for flat roof system east-west I for placement and fixing of the C-rail 71, available for the base trough 150-30 or the base trough 230-90.

Item no.	Designation	a in mm	b in mm	c in mm	Material
03-000181	Module support set east-west 230	180	50	60	Alu / A2SS
03-000180	Module support set east-west 150	180	50	50	Alu / A2SS

Module support closed I

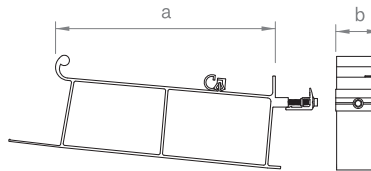

Module support for flat roof system closed I, for fixed elevation of modules at an angle of 13° and to connect the wind deflector 13° on it, securing the modules on the long side of the frame, for frame heights 28 – 33 mm, 34 – 42 mm or 43 – 52 mm, completely pre-assembled.

Item no.	Designation	a in mm	b in mm	c in mm	Material
03-000330	Module support set 13° 28 – 33 mm	255	50		Alu / A2SS
03-000030	Module support set 13° 34 – 42 mm	255	50		Alu / A2SS
03-000031	Module support set 13° 43 – 52 mm	255	50		Alu / A2SS

Wind deflector closed I

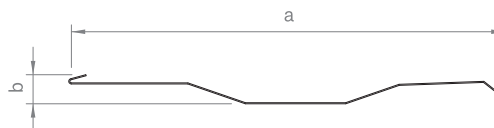
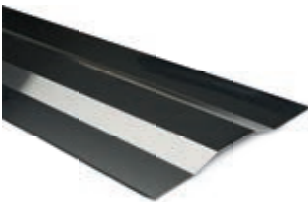

Wind deflector for flat roof system closed I for wind deflection and ballast reduction.

Item no.	Designation	a in mm	b in mm	c in mm	Material
03-001464	Wind deflector 13° 2.35 m	330	23		Alu

Module elevation and module attachment

Module bracket back east-west I

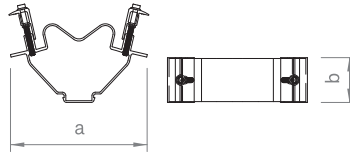

Module support for flat roof system east-west I, to clip into the C-rail, fixing the modules on the long side of the frame, for frame heights 28 – 33 mm, 34 – 42 mm or 43 – 52 mm.

Item no.	Designation	a in mm	b in mm	c in mm	Material
03-000322	Module bracket set back east-west 28–33 mm	159	52		Alu / A2SS
03-000098	Module bracket set back east-west 34–42 mm	159	52		Alu / A2SS
03-000095	Module bracket set back east-west 43–52 mm	159	52		Alu / A2SS

Module bracket front mounting hole

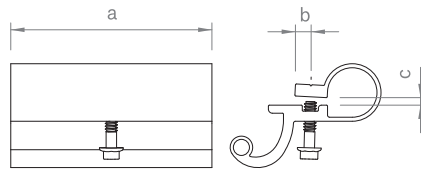

Front module support for flat roof system generation I or elevation on pitched roof, to connect to the module frame holes, completely pre-assembled.

Item no.	Designation	a in mm	b in mm	c in mm	Material
03-000078	Module bracket set front	100	8	4	Alu / A2SS

Module bracket set direct box frame

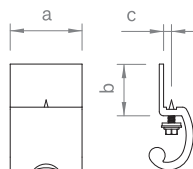

Front module support for flat roof system generation I or elevation on pitched roof, to directly connect to the module frame without frame holes, completely pre-assembled.

Item no.	Designation	a in mm	b in mm	c in mm	Material
03-000239	Module bracket set front direct (box fr.)	50	36	5,5	Alu / A2SS

Module elevation and module attachment

Module bracket back mounting hole



Rear module support for flat roof system I open or elevation on pitched roof, to connect to the module frame holes, completely pre-assembled.

Item no.	Designation	a in mm	b in mm	c in mm	Material
03-000061	Module bracket set back	65	8	4	Alu / A2SS

Module support 13° - 40° open



Rear module support for flat roof system I open or elevation on pitched roof, in different lengths to elevate modules, continuous adjustable elevation angle, completely pre-assembled.

Item no.	Designation	a in mm	b in mm	c in mm	Material
03-000070	Module support set 200mm	200	100	100	Alu
03-000071	Module support set 280mm	280	100	100	Alu
03-000083	Module support set 360mm	360	100	100	Alu
03-000022	Module support set 440mm	440	100	100	Alu
03-000072	Module support set 520mm	520	100	100	Alu

Connector flat roof components

Flat roof mounting screws

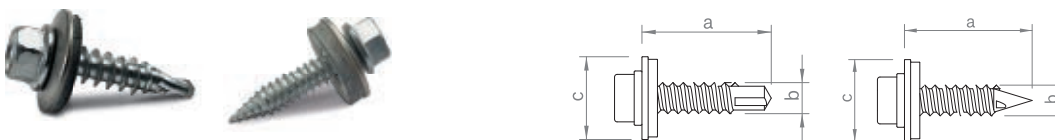

Self-drilling screw or thin sheet screw with 8 AF hexagon drive for connecting flat roof components.

Item no.	Designation	a in mm	b in mm	c in mm	Material
03-000132	Flat roof mounting screw	25	6	16	A2SS
03-000383	Flat roof mounting screw cl 5.5	25	5.5	16	A2SS

Accessories and optional components

Mounting-set optimizer FR



Mounting-Set for flat roof system generation II with thin sheet screws with 8 AF hexagon drive, for fixing components like e.g. optimizer at module supports

Item no.	Designation	a in mm	b in mm	c in mm	Material
03-000337	Mounting-set optimizer FR				Alu / A2SS

Grounding connector base trough



Grounding connector set sufficient for clamping cables of 6-16 mm² or wire with diameter 6-10 mm.

Item no.	Designation	a in mm	b in mm	c in mm	Material
03-000012	Grounding connector C-rail				A2SS

Contact latch module clamp



Contact latch for equipotential bonding / lightning current carrying capacity between module frame and mounting system. Suitable for all middle clamps C-rail and flat roof.

Item no.	Designation	a in mm	b in mm	c in mm	Material
03-001185	Contact latch module clamp				V2A

Perforated Alu-tape



Perforated Alu-tape for boosting efficiency of mounting system parts to lightning current carrying capacity.

Item no.	Designation	a in mm	b in mm	c in mm	Material
03-000924	Perforated Alu-tape 10.000 x 20 x 1 mm				Alu

Accessories and optional components

Aluminium edge protector



Aluminium edge protector, self-adhesive, to laminate base trough ends or sliced base trough connections.

Item no.	Designation	a in mm	b in mm	c in mm	Material
03-000407	Aluminium edge protector self-adhesive				Alu

PE-Pad



PE-Pad to laminate on site sliced base trough 150-30 for transverse drainage.

Item no.	Designation	a in mm	b in mm	c in mm	Material
03-000831	PE-Pad 140 x 390 x 20 mm				PE

Protective roof mat



Protective roof mat for laying below the base trough 230-90 as a protection layer for flat roof elevation.

Item no.	Designation	a in mm	b in mm	c in mm	Material
03-000105	Protective roof mat 10.000 x 250 x 6 mm				

Synthetic fibre strips



Synthetic fibre stripe as a separation layer between the protective roof mat and the flat roof membran in use with flat roof systems.

Item no.	Designation	a in mm	b in mm	c in mm	Material
03-000113	Synthetic fibre strips 50.000 x 320				Vlies

Accessories and optional components

Cable bracket



Cable bracket for secure laying of cable in the base trough 150-30.

Item no.	Designation	a in mm	b in mm	c in mm	Material
03-000175	Base trough cable bracket				PP

Clip



Cable clip, for cable bundle up to 10 mm diameter, with clip to connect to the module frame or similar.

Item no.	Designation	a in mm	b in mm	c in mm	Material
03-000099	Cable clip d=10 mm				PA
03-000510	Cable collector N-rail PA 4 cables				PP

Cable tie with or without clip



Black polyamide plastic, UV-resistant for tool-free fastening on rails, for 1-3 mm or 3-6 mm metal flange.

Item no.	Designation	a in mm	b in mm	c in mm	Material
03-000504	Cable-tie black, 140 mm				PP
03-000505	Cable-tie black, 200 mm				PP
03-000506	Cable-tie black, 280 mm				PP
03-000507	Cable-tie black, 360 mm				PP
03-000508	Cable-tie clip for profile flange 1 - 3 mm				PP
03-000509	Cable-tie clip for profile flange 3 - 6 mm				PP

Mounting screw



Thin sheet screw without sealant, with 8 A/F hexagon drive for connecting flat roof components.

Item no.	Designation	a in mm	b in mm	c in mm	Material
03-000778	Flat roof mounting screw cl 5.5				A2SS

Single items green roof

Substrate plate green roof

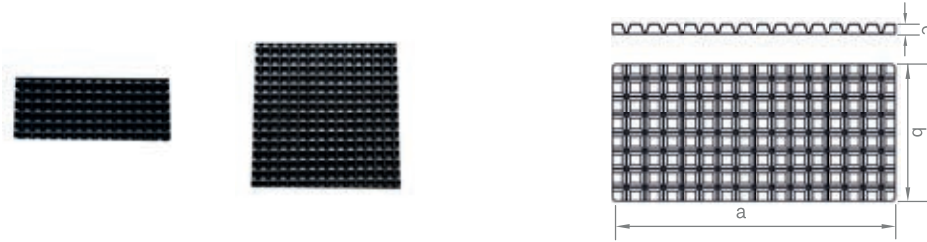

For the application of substrate for ballasting. Honeycomb structure in 10 cm grid for flexible positioning of supports. Made in Germany from recycled, UV-resistant plastic.

Item no.	Designation	a in mm	b in mm	c in mm	Material
03-001507	Substrate plate green roof	1550	1550	52	Recycled plastic
03-001508	Substrate plate 1/2 green roof	1550	750	52	Recycled plastic

Module support green roof



Front or rear module support for the green roof system. Made in Germany from recycled, UV-resistant plastic.

Item no.	Designation	a in mm	b in mm	c in mm	Material
03-001505	Module support high green roof	625	300	200	Recycled plastic
03-001506	Module support low green roof	462	300	200	Recycled plastic

Module support mounting screw green roof



Countersunk screw with Torx 25 drive for connecting substrate plate and module support.

Item no.	Designation	a in mm	b in mm	c in mm	Material
03-001493	Module support mounting screw 6x80 green roof	80	6		St. galv.

Green roof module support rail 5.40 m



Mounting rail with cable channel, can be used as a module support rail for the green roof system. Rail base with round, 15 mm holes in a 300 mm grid for drainage.

Item no.	Designation	a in mm	b in mm	c in mm	Material
03-001514	Green roof module support rail 5.40 m	54	69		Alu

Module support rail mounting screw green roof

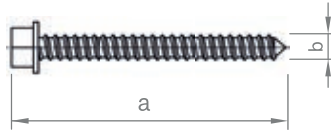

Threaded screw with hexagonal drive SW 8 for connecting module support and module support rail.

Item no.	Designation	a in mm	b in mm	c in mm	Material
03-001491	Module support rail mounting screw green roof	51	6,5		St. galv.

Rail connector C-rail 47 profile chambers

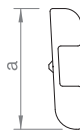

Connector C-rail 47, l = 200 mm, screw connection with four self-drilling screws with 8 AF hexagon drive.

Item no.	Designation	a in mm	b in mm	c in mm	Material
03-000925	Rail connector set C47 S	30			Alu / A2SS

Middle clamps for C-rail, C-N-rail und green roof module support rail

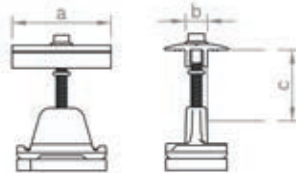

Middle clamp for fixing the modules to the C-rail, C-N-rail or green roof module support rail. Installation-friendly thanks to click-in mechanism. Clamping screw with 8 AF hexagon drive. For frame heights of 30–42 mm or 43–52 mm, available in blank or black anodised variations.

Item no.	Designation	a in mm	b in mm	c in mm	Material
03-001345	Middle clamp 30-42 Set C	52	11,4	30–42	Alu / A2SS / PE
03-000285	Middle clamp 43-52 Set C	52	11,4	43–52	Alu / A2SS / PE
03-001346	Middle clamp 30-42 Set C black	52	11,4	30–42	Alu / A2SS / PE
03-000286	Middle clamp 43-52 Set C black	52	11,4	43–52	Alu / A2SS / PE

End clamps for C-rail, C-N-rail und green roof module support rail

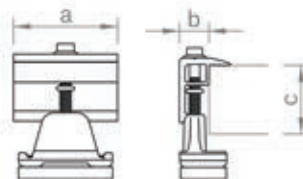

End clamp for fixing the modules to the C-rail, C-N-rail or green roof module support rail. Installation-friendly thanks to click-in mechanism. Clamping screw with 8 AF hexagon drive. For frame heights of 30–42 mm or 43–52 mm, available in blank or black anodised variations.

Item no.	Designation	a in mm	b in mm	c in mm	Material
03-001236	End clamp 30-42 Set C	52	14	30–42	Alu / A2SS / PE
03-000287	End clamp 43-52 Set C	52	14	43–52	Alu / A2SS / PE
03-001237	End clamp 30-42 Set C sw	52	14	30–42	Alu / A2SS / PE
03-000288	End clamp 43-52 Set C sw	52	14	43–52	Alu / A2SS / PE

Tools



Item no.	Designation	Roof type*	Picture
03-000100	special nut socket 8 mm	all roofs	1
03-000011	special long nut socket 18 mm	ZD, W/S, Trapez, BF, FD I	2
03-000036	Torque wrench 1/4", 4-20 Nm	ZD, W/S, Trapez, BF, FD I + II	3
03-000037	Torque wrench 1/2", 20-100 Nm	ZD, W/S, Trapez, BF, FD I	4
03-000362	Mounting and removal tool 150-30	FD I + II	5
03-000602	Adapter 1/4" hexagonal to 1/2" square	ZD, W/S, Trapez, BF, FD I	6
03-000576	Assembling jig 800-1200 mm, C-shaped	ZD, W/S, Trapez, BF, FD I + II	7
03-000574	Assembling jig 1300-1700mm, C-shaped	ZD, W/S, Trapez, BF, FD I + II	7
03-000577	Assembling jig 800-1200 mm, C-shaped	ZD, W/S, Trapez, BF, FD I + II	7
03-000575	Assembling jig 1300-1700mm ohne, C-shaped	ZD, W/S, Trapez, BF, FD I + II	7

* type of roof:
 ZD = tile roof
 W/S = corrugated and sandwich roof
 Trapez = trapezoidal roof
 BF = seamed roof
 FD = flat roof



The perfect solution for every flat roof.





5

Customized
solutions

Facade system



Clear added value for your facade

- vertical photovoltaic system on the facade – separated from the building and well back-ventilated
- mounting exclusively on solid building walls (brick, concrete or stone) without external thermal insulation
- few individual components, entirely pre-assembled
- use of our proven insertion rail

Product variants

- different rail height of the insertion rail 30-50 mm in black anodised or blank
- mounting modules in portrait or in landscape

Your benefits

- high-end installation aesthetics and time-efficient mounting thanks to insertion technology
- tension-free and floating module mounting
- flexible system size: From a single module to the entire facade surface
- a construction with excellent rear ventilation which hangs in front of the building but does not touch it



Few components - simple and fast installation



Very good rear ventilation of the modules



Dowels with technical approval

Facade

Sockets insertion rail

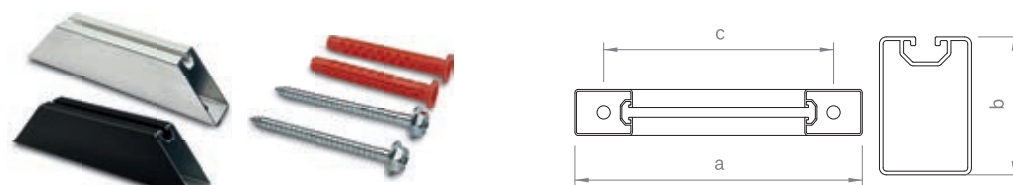

Socket for fixing insertion rails on building facades, drill holes $d = 11.5\text{ mm}$, delivered with two facade dowels and the matching screws.

Item no.	Designation	a in mm	b in mm	c in mm	Material
03-000580	Socket set 250 mm 11.5	250	60	200	Alu / A2SS
03-000581	Socket set 250 mm 11.5 black	250	60	200	Alu / A2SS

Adapter plates module protection and perforated sheet fixing

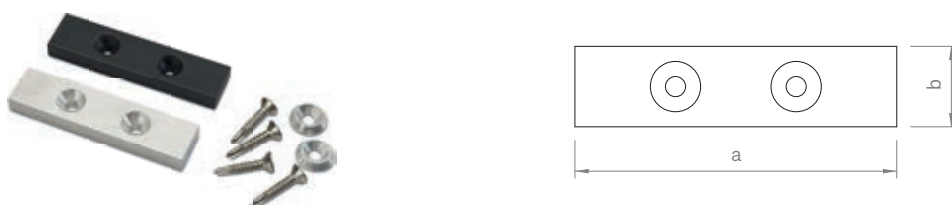

Adapter plate for securing the modules against slipping and for fixing perforated sheets. Prefabricated with two 5 mm drill holes for attachment on the socket as well as two countersunk washers and four countersunk head self-drilling screws with Torx drive 25.

Item no.	Designation	a in mm	b in mm	c in mm	Material
03-000384	Adapter plate set $80 \times 20 \times 8\text{ mm}$	80	20		Alu / A2SS
03-000404	Adapter plate set $80 \times 20 \times 8\text{ mm}$ black	80	20		Alu / A2SS

Adapter plates edge stop and perforated sheet fixing

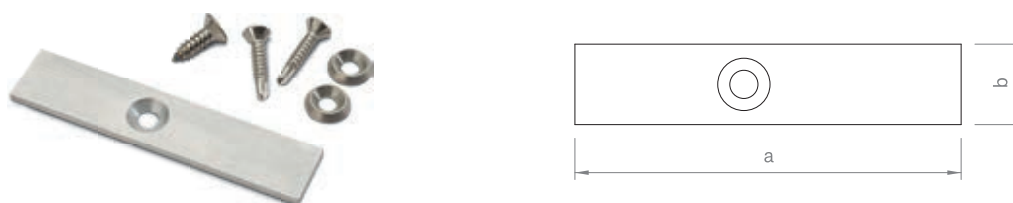

Adapter plate for lateral fixing of perforated sheets and as an edge stop for the modules. Prefabricated with a 7 mm drill hole for a countersunk head sheet screw with Torx drive 30 as well as two countersunk self-drilling screws with Torx drive 25.

Item no.	Designation	a in mm	b in mm	c in mm	Material
03-000385	Adapter plate set $96 \times 20 \times 3\text{ mm}$	96	20		Alu / A2SS

Perforated sheets



Perforated sheet to close the gap between the facade and module, enables rear ventilation and quick access to the rear of the modules, available in blank or black.

Item no.	Designation	a in mm	b in mm	c in mm	Material
03-000548	Perforated sheet $1500 \times 120\text{ mm}$ 125°	83	38		St. galv.
03-000549	Perforated sheet $1500 \times 120\text{ mm}$ 125° black	83	38		St. galv.

In-roof system



Slide in, screw down - done!

- black glass-foil modules with special frame
- shingled in-roof system (like tile)
- replaces conventional roofing
- european components and production

product variants

- integration of skylights, blind modules or snow guard

Your benefits

- all functions integrated in the frame
- very simple and fast assembly
- maximum aesthetics and flexibility
- optimum price / performance ratio



Premium energy saving roof windows



Integratable snow guard assembly



Blind module as a natural finish



In-roof system – aesthetic,
intelligent and fast

Terms of guarantee

Product guarantee of novotegra GmbH

Terms of guarantee

Under the following conditions, novotegra GmbH guarantees that under normal conditions of installation, application, operation and maintenance the components of the mounting system are free of construction, processing and material defects, for 12 years from the date of receipt.

Only novotegra GmbH may approve the warranty claim, and only through an independent test on-site. In the case of an approved warranty claim the liability is effected solely through a replacement delivery of the defective component. An approved warranty claim does not lead to an extension of the guarantee period, nor restart it. Subsequent to an accepted warranty claim, no further commitments and liabilities for additional and subsequent damages for novotegra GmbH exist. Thus a limitation of the legal warranty claims and the legal product liability is not given.

Warranty claim

In order to file a claim within 12 years, you must notify novotegra GmbH in writing within two weeks of the detection of the fault and supply the purchase date, the original order confirmation and delivery note from novotegra GmbH as proof of purchase. The guarantor is novotegra GmbH, Eisenbahnstraße 150, 72072 Tübingen. The areas covered by this guarantee are based upon German law principles with the exclusion of UN purchasing law (CISG). Furthermore, our general terms and conditions apply in addition to this guarantee.

Exclusions

Warranty claims under this guarantee cannot be made in case of:

- Faulty or incorrect installation according to the installation instructions.
- Unauthorised modifications or repairs.
- Inappropriate installation or use of the mounting system.
- Inappropriate transportation, storage or handling of the components.
- Optical deficiencies in so far as the appearance does not have any influence on the performance of the component.
- Incorrect installation according to the static calculations, or installation instructions of other components (for example, the solar module).
- Failure to comply with universally valid norms that have to be respected during installation.
- Damage through e.g. smoke, exceptional thermal stress, salt loading or other chemical products.
- Forces of nature (natural hazard), force majeure, vandalism, destruction through external influences and / or persons / animals.

The cost to novotegra GmbH for the removal and return of the defective component as well as for the re-assembly of the delivered component are excluded from this guarantee.



Hand-in-hand for your success

You are looking for a proven mounting system for a pitched or flat roof?

We are happy to help you plan your installation and support you with our professional expertise.

BayWa r.e. Solar Energy Systems GmbH
Eisenbahnstraße 150, 72072 Tübingen, Germany
Phone: +49 7071 98987 0
solarenergysystems@baywa-re.com

Solarmarkt GmbH
Neumattstrasse 2, 5000 Aarau, Switzerland
Phone: +41 62 834 00 80
info@solarmarkt.ch

BayWa r.e. Solar Systems S.à r.l.
4, Op der Haart, 9999 Wemperhardt, Luxembourg
Phone: +352 27802820
solarsystems@baywa-re.lu

BayWa r.e. France SAS
3, rue Cantelaudette, 33310 Lormont, France
Phone: +33 1 55 31 49 80
solarsystems@baywa-re.fr

BayWa r.e. España S.L.U.
Gran Via de les Corts Catalanes 657, Ent.,
08010 Barcelona, Spain
Phone: +34 936 033 110
info.solarsystems@baywa-re.es

BayWa r.e. Solar Systems srl
Anello Nord, 25, 39031 Brunico (BZ), Italy
Phone: +39 0474 375 050
info.solarsystems@baywa-re.it

BayWa r.e. Solar Energy Systems GmbH
Wirtschaftspark 15, 9130 Poggendorf, Austria
Phone: + 43 4224 34410 00
austria@baywa-re.com

BayWa r.e. Solar Systems Danmark
Kullinggade 31E, 5700 Svendborg, Denmark
Phone: +45 62 21 10 00
solarsystemer@baywa-re.com

BayWa r.e. Solar Systems Filial
Torshamnsgatan 20, 16440 Stockholm, Sweden
Phone: +46 40 9798 85
scandinavia@baywa-re.com

BayWa r.e. Solar Systems Sp.z o.o.
Krakowska 390, 32-080 Zabierzów, Poland
Phone: +48 574 186 300
biuro.solarsystemspl@baywa-re.com

Imprint
novotegra GmbH
Eisenbahnstraße 150 | 72072 Tuebingen | Phone: +49 7071 98987-0 | info@novotegra.com | www.novotegra.com
Concept and text novotegra GmbH, Tuebingen
Design concept Strichpunkt GmbH, Stuttgart | Berlin
Graphics mds Agenturgruppe GmbH
Photography Ben Wiesenfarth, Konstanz; Reiner Pfisterer, Ludwigsburg
Reproduction novotegra, Tuebingen
Printing Mayer & Söhne Druck- und Mediengruppe GmbH & Co. KG, Aichach, Version CA-093.06
Copyright-Hinweis April 2021 novotegra GmbH, Tübingen. Subject to changes and errors excepted.
Product pictures and system drawings may differ from the original components.
Reproduction only permissible on an excerpt basis and with prior written consent from novotegra GmbH.



novotégra

novotegra GmbH
Eisenbahnstr. 150
72072 Tuebingen
Germany

Phone: +49 7071 98987-0
Fax: +49 7071 98987-10

info@novotegra.com
www.novotegra.com

